



Zahnriemen
Timing belts

GSM GUARDING
SURFACE
METAL



Inhaltsverzeichnis

Summary

Zahnriemen – zöllig – Chloropren

Timing Belts – inch – Chloroprene

Doppel-Zahnriemen – zöllig – Chloropren

Double Timing Belts – inch – Chloroprene

Chloropren

Timing Belts – M – Chloroprene

Hochleistungs-Zahnriemen PP – Chloropren

High Performance Timing Belts – Chloroprene

Doppel-Zahnriemen – M – Chloropren

Double Timing Belts – M – Chloroprene

Zahnriemen – STD – Chloropren

Timing Belts – STD – Chloroprene

Doppel-Zahnriemen – STD – Chloropren

Double Timing Belts – STD – Chloroprene

Zahnriemen – Meterware – Chloropren

Open-ended Timing Belts – Chloroprene

Zahnriemen – T – Polyurethan, mit Stahlzugstrang

Timing Belts – T – Polyurethane

Zahnriemen – AT – Polyurethan, mit Stahlzugstrang

Timing Belts – AT – Polyurethane

Doppel-Zahnriemen – T – Polyurethan, mit Stahlzugstrang

Double Timing Belts – T – Polyurethane

Zahnriemen – zöllig – Polyurethan, mit Aramidzugstrang /Stahlzugstrang

Timing Belts – inch – Polyurethane / steel wire cord

Zahnriemen – zöllig – Chloropren Timing Belts – inch – Chloroprene

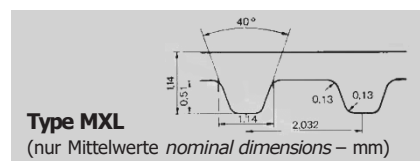

Type MXL – Teilung pitch 2,032 mm

Artikel- Bezeichnung Designation	Wirklänge Pitch length		Anzahl der Zähne Number of teeth	1/8" Breite width ≈ 3,175 mm Code-No. 012	3/16" Breite width ≈ 4,763 mm Code-No. 019	1/4" Breite width ≈ 6,35 mm Code-No. 025
	(Zoll inch)	(mm)		€ Stück each	€ Stück each	€ Stück each
264 MXL	2,64	67,06	33			
360 MXL	3,60	91,44	45			
432 MXL	4,32	109,73	54			
440 MXL	4,40	111,76	55			
448 MXL	4,48	113,79	56			
456 MXL	4,56	115,82	57			
464 MXL	4,64	117,86	58			
480 MXL	4,80	121,92	60			
488 MXL	4,88	123,95	61			
536 MXL	5,36	136,14	67			
544 MXL	5,44	138,18	68			
560 MXL	5,60	142,24	70			
568 MXL	5,68	144,27	71			
576 MXL	5,76	146,30	72			
600 MXL	6,00	152,40	75			
608 MXL	6,08	154,43	76			
632 MXL	6,32	160,53	79			
640 MXL	6,40	162,56	80			
656 MXL	6,56	166,62	82			
664 MXL	6,64	168,66	83			
672 MXL	6,72	170,69	84			
680 MXL	6,80	172,72	85			
704 MXL	7,04	178,82	88			
720 MXL	7,20	182,88	90			
728 MXL	7,28	184,91	91			
736 MXL	7,36	186,94	92			
752 MXL	7,52	191,01	94			
760 MXL	7,60	193,04	95			
776 MXL	7,76	197,10	97			
800 MXL	8,00	203,20	100			
808 MXL	8,08	205,23	101			
816 MXL	8,16	207,26	102			
824 MXL	8,24	209,30	103			
840 MXL	8,40	213,36	105			
848 MXL	8,48	215,39	106			
856 MXL	8,56	217,42	107			
864 MXL	8,64	219,46	108			
880 MXL	8,80	223,52	110			
896 MXL	8,96	227,58	112			
904 MXL	9,04	229,62	113			
912 MXL	9,12	231,65	114			
920 MXL	9,20	233,68	115			
960 MXL	9,60	243,84	120			
976 MXL	9,76	247,90	122			
984 MXL	9,84	249,94	123			
1000 MXL	10,00	254,00	125			
1008 MXL	10,08	256,03	126			
1040 MXL	10,40	264,16	130			
1056 MXL	10,56	268,22	132			
1072 MXL	10,72	272,29	134			
1080 MXL	10,80	274,32	135			
1112 MXL	11,12	282,45	139			
1120 MXL	11,20	284,48	140			
1136 MXL	11,36	288,54	142			

auf
Anfrage
on
request

Weitere Abmessungen auf Anfrage. Further sizes on request.

Zahnriemen – zöllig – Chloropren Timing Belts – inch – Chloroprene

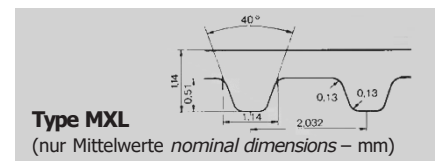

Type MXL – Teilung pitch 2,032 mm

Artikel- Bezeichnung Designation	Wirklänge Pitch length		Anzahl der Zähne Number of teeth	1/8" Breite width ≈ 3,175 mm Code-No. 012	3/16" Breite width ≈ 4,763 mm Code-No. 019	1/4" Breite width ≈ 6,35 mm Code-No. 025
	(Zoll inch)	(mm)		€ Stück each	€ Stück each	€ Stück each
1176 MXL	11,76	298,70	147			
1184 MXL	11,84	300,74	148			
1200 MXL	12,00	304,80	150			
1224 MXL	12,24	310,90	153			
1272 MXL	12,72	323,09	159			
1280 MXL	12,80	325,12	160			
1320 MXL	13,20	335,28	165			
1360 MXL	13,60	345,44	170			
1400 MXL	14,00	355,60	175			
1440 MXL	14,40	365,76	180			
1472 MXL	14,72	373,89	184			
1520 MXL	15,20	386,08	190			
1560 MXL	15,60	396,24	195			
1600 MXL	16,00	406,40	200			
1768 MXL	17,68	449,07	221			
1800 MXL	18,00	457,20	225			
1888 MXL	18,88	479,55	236			
1984 MXL	19,84	503,94	248			
1992 MXL	19,92	505,97	249			
2008 MXL	20,08	510,03	251			
2048 MXL	20,48	520,19	256			
2144 MXL	21,44	544,58	268			
2240 MXL	22,40	568,96	280			
2384 MXL	23,84	605,54	298			
2480 MXL	24,80	629,92	310			
2520 MXL	25,20	640,08	315			
2776 MXL	27,76	705,10	347			
2880 MXL	28,80	731,52	360			
2920 MXL	29,20	741,68	365			
3200 MXL	32,00	812,80	400			
3472 MXL	34,72	881,89	434			
3624 MXL	36,24	920,50	453			
3704 MXL	37,04	940,82	463			
3984 MXL	39,84	1011,94	498			
4040 MXL	40,40	1026,16	505			

auf
Anfrage
on
request

Weitere Abmessungen auf Anfrage. Further sizes on request.

Zahnriemen – zöllig – Chloropren Timing Belts – inch – Chloroprene

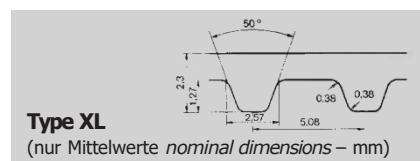

Type XL – Teilung pitch 5,08 mm

Artikel- Bezeichnung Designation	Wirklänge Pitch length		Anzahl der Zähne Number of teeth	1/4" Breite width ≈ 6,35 mm Code-No. 025	5/16" Breite width ≈ 7,94 mm Code-No. 031	3/8" Breite width ≈ 9,53 mm Code-No. 037
	(Zoll inch)	(mm)		€ Stück each	€ Stück each	€ Stück each
60 XL	6,00	152,40	30			
70 XL	7,00	177,80	35			
80 XL	8,00	203,20	40			
86 XL	8,60	218,44	43			
88 XL	8,80	223,52	44			
90 XL	9,00	228,60	45			
92 XL	9,20	233,68	46			
94 XL	9,40	238,76	47			
96 XL	9,60	243,84	48			
98 XL	9,80	248,92	49			
100 XL	10,00	254,00	50			
102 XL	10,20	259,08	51			
106 XL	10,60	269,24	53			
108 XL	10,80	274,32	54			
110 XL	11,00	279,40	55			
112 XL	11,20	284,48	56			
116 XL	11,60	294,64	58			
118 XL	11,80	299,72	59			
120 XL	12,00	304,80	60			
124 XL	12,40	314,96	62			
126 XL	12,60	320,04	63			
128 XL	12,80	325,12	64			
130 XL	13,00	330,20	65			
134 XL	13,40	340,36	67			
136 XL	13,60	345,44	68			
138 XL	13,80	350,52	69			
140 XL	14,00	355,60	70			
142 XL	14,20	360,68	71			
148 XL	14,80	375,92	74			
150 XL	15,00	381,00	75			
156 XL	15,60	396,24	78			
160 XL	16,00	406,40	80			
162 XL	16,20	411,48	81			
166 XL	16,60	421,64	83			
168 XL	16,80	426,72	84			
170 XL	17,00	431,80	85			
174 XL	17,40	441,96	87			
176 XL	17,60	447,04	88			
178 XL	17,80	452,12	89			
180 XL	18,00	457,20	90			
182 XL	18,20	462,28	91			
184 XL	18,40	467,36	92			
188 XL	18,80	477,52	94			
190 XL	19,00	482,60	95			
192 XL	19,20	487,68	96			
194 XL	19,40	492,76	97			
196 XL	19,60	497,84	98			
198 XL	19,80	502,92	99			
200 XL	20,00	508,00	100			
210 XL	21,00	533,40	105			
220 XL	22,00	558,80	110			
230 XL	23,00	584,20	115			
240 XL	24,00	609,60	120			
244 XL	24,40	619,76	122			
248 XL	24,80	629,92	124			
250 XL	25,00	635,00	125			

auf
Anfrage
on
request

Zahnriemen – zöllig – Chloropren Timing Belts – inch – Chloroprene

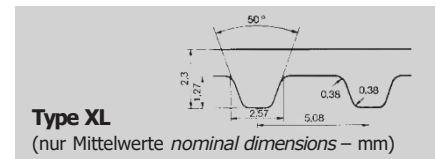

Type XL – Teilung pitch 5,08 mm

Artikel- Bezeichnung Designation	Wirklänge Pitch length		Anzahl der Zähne Number of teeth	1/4" Breite width ≈ 6,35 mm Code-No. 025	5/16" Breite width ≈ 7,94 mm Code-No. 031	3/8" Breite width ≈ 9,53 mm Code-No. 037
	(Zoll inch)	(mm)		€ Stück each	€ Stück each	€ Stück each
260 XL	26,00	660,40	130			
270 XL	27,00	685,80	135			
272 XL	27,20	690,88	136			
274 XL	27,40	695,96	137			
280 XL	28,00	711,20	140			
286 XL	28,60	726,44	143			
290 XL	29,00	736,60	145			
296 XL	29,60	751,84	148			
300 XL	30,00	762,00	150			
306 XL	30,60	777,24	153			
310 XL	31,00	787,40	155			
316 XL	31,60	802,64	158			
320 XL	32,00	812,80	160			
322 XL	32,20	817,88	161			
330 XL	33,00	838,20	165			
340 XL	34,00	863,60	170			
344 XL	34,40	873,76	172			
350 XL	35,00	889,00	175			
360 XL	36,00	914,40	180			
380 XL	38,00	965,20	190			
382 XL	38,20	970,28	191			
388 XL	38,80	985,52	194			
390 XL	39,00	990,60	195			
392 XL	39,20	995,68	196			
412 XL	41,20	1046,48	206			
414 XL	41,40	1051,56	207			
432 XL	43,20	1097,28	216			
434 XL	43,40	1102,36	217			
438 XL	43,80	1112,52	219			
460 XL	46,00	1168,40	230			
498 XL	49,80	1264,92	249			
506 XL	50,60	1285,24	253			
514 XL	51,40	1305,56	257			
580 XL	58,00	1473,20	290			
630 XL	63,00	1600,20	315			

auf
Anfrage
on
request

Weitere Abmessungen auf Anfrage. Further sizes on request.

Zahnriemen – zöllig – Chloropren Timing Belts – inch – Chloroprene

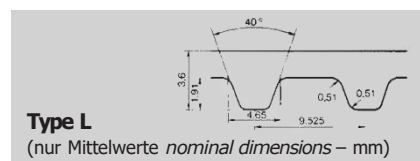

Type L – Teilung pitch 9,525 mm

Artikel- Bezeichnung Designation	Wirklänge Pitch length		Anzahl der Zähne Number of teeth	1/2" Breite width ≈ 12,7 mm Code-No. 050	3/4" Breite width ≈ 19,05 mm Code-No. 075	1" Breite width ≈ 25,4 mm Code-No. 100
	(Zoll inch)	(mm)		€ Stück each	€ Stück each	€ Stück each
109 L	10,88	276,23	29			
124 L	12,38	314,33	33			
150 L	15,00	381,00	40			
165 L	16,50	419,10	44			
169 L	16,88	428,63	45			
173 L	17,25	438,15	46			
187 L	18,75	476,25	50			
202 L	20,25	514,35	54			
210 L	21,00	533,40	56			
225 L	22,50	571,50	60			
232 L	23,25	590,55	62			
236 L	23,63	600,08	63			
240 L	24,00	609,60	64			
255 L	25,50	647,70	68			
259 L	25,90	657,23	69			
263 L	26,30	666,75	70			
270 L	27,00	685,80	72			
285 L	28,50	723,90	76			
300 L	30,00	762,00	80			
322 L	32,25	819,15	86			
345 L	34,50	876,30	92			
360 L	36,00	914,40	96			
367 L	36,75	933,45	98			
375 L	37,50	952,50	100			
390 L	39,00	990,60	104			
405 L	40,50	1028,70	108			
420 L	42,00	1066,80	112			
424 L	42,38	1076,33	113			
427 L	42,75	1085,85	114			
435 L	43,50	1104,90	116			
439 L	43,90	1114,43	117			
450 L	45,00	1143,00	120			
454 L	45,38	1152,53	121			
480 L	48,00	1219,20	128			
510 L	51,00	1295,40	136			
525 L	52,50	1333,50	140			
540 L	54,00	1371,60	144			
600 L	60,00	1524,00	160			
630 L	63,00	1600,20	168			
660 L	66,00	1676,40	176			
817 L	81,70	2075,18	218			

auf
Anfrage
on
request

Weitere Abmessungen auf Anfrage. Further sizes on request.

Zahnriemen – zöllig – Chloropren Timing Belts – inch – Chloroprene

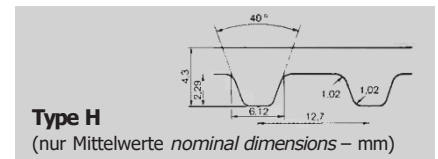

Type H – Teilung pitch 12,7 mm

Artikel- Bezeichnung Designation	Wirklänge Pitch length		Anzahl der Zähne Number of teeth	3/4" Breite width ≈ 19,05 mm Code-No. 075	1" Breite width ≈ 25,4 mm Code-No. 100	1 1/2" Breite width ≈ 38,1 mm Code-No. 150	2" Breite width ≈ 50,8 mm Code-No. 200	3" Breite width ≈ 76,2 mm Code-No. 300
	(Zoll inch)	(mm)		€ Stück each	€ Stück each	€ Stück each	€ Stück each	€ Stück each
230 H	23,00	584,20	46					
240 H	24,00	609,60	48					
255 H	25,50	647,70	51					
270 H	27,00	685,80	54					
280 H	28,00	711,20	56					
300 H	30,00	762,00	60					
310 H	31,00	787,40	62					
315 H	31,50	800,10	63					
320 H	32,00	812,80	64					
330 H	33,00	838,20	66					
335 H	33,50	850,90	67					
340 H	34,00	863,60	68					
350 H	35,00	889,00	70					
360 H	36,00	914,40	72					
370 H	37,00	939,80	74					
375 H	37,50	952,50	75					
390 H	39,00	990,60	78					
400 H	40,00	1016,00	80					
410 H	41,00	1041,40	82					
420 H	42,00	1066,80	84					
430 H	43,00	1092,20	86					
450 H	45,00	1143,00	90					
465 H	46,50	1181,10	93					
480 H	48,00	1219,20	96					
490 H	49,00	1244,60	98					
510 H	51,00	1295,40	102					
520 H	52,00	1320,80	104					
530 H	53,00	1346,20	106					
540 H	54,00	1371,60	108					
560 H	56,00	1422,40	112					
570 H	57,00	1447,80	114					
580 H	58,00	1473,20	116					
600 H	60,00	1524,00	120					
630 H	63,00	1600,20	126					
650 H	65,00	1651,00	130					
660 H	66,00	1676,40	132					
670 H	67,00	1701,80	134					
680 H	68,00	1727,20	136					
700 H	70,00	1778,00	140					
720 H	72,00	1828,80	144					
730 H	73,00	1854,20	146					
750 H	75,00	1905,00	150					
770 H	77,00	1955,80	154					
800 H	80,00	2032,00	160					
810 H	81,00	2057,40	162					
820 H	82,00	2082,80	164					
850 H	85,00	2159,00	170					
860 H	86,00	2184,40	172					
900 H	90,00	2286,00	180					
950 H	95,00	2413,00	190					
1000 H	100,00	2540,00	200					
1100 H	110,00	2794,00	220					
1120 H	112,00	2844,80	224					
1140 H	114,00	2895,60	228					
1150 H	115,00	2921,00	230					
1250 H	125,00	3175,00	250					
1400 H	140,00	3556,00	280					
1700 H	170,00	4318,00	340					

auf
Anfrage
on
request

Weitere Abmessungen auf Anfrage. Further sizes on request.

Zahnriemen – zöllig – Chloropren Timing Belts – inch – Chloroprene

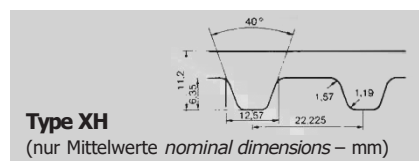

Type XH – Teilung *pitch* 22,225 mm

Artikel- Bezeichnung <i>Designation</i>	Wirklänge <i>Pitch length</i>		Anzahl der Zähne <i>Number of teeth</i>	2" Breite <i>width</i> ≈ 50,8 mm Code-No. 200	3" Breite <i>width</i> ≈ 76,2 mm Code-No. 300	4" Breite <i>width</i> ≈ 101,6 mm Code-No. 400	5" Breite <i>width</i> ≈ 127 mm Code-No. 500
	(Zoll <i>inch</i>)	(mm)		€ Stück <i>each</i>	€ Stück <i>each</i>	€ Stück <i>each</i>	€ Stück <i>each</i>
507 XH	50,75	1289,05	58				
560 XH	56,00	1422,40	64				
630 XH	63,00	1600,20	72				
700 XH	70,00	1778,00	80				
770 XH	77,00	1955,80	88				
840 XH	84,00	2133,60	96				
980 XH	98,00	2489,20	112				
1120 XH	112,00	2844,80	128				
1260 XH	126,00	3200,40	144				
1400 XH	140,00	3556,00	160				
1540 XH	154,00	3911,60	176				
1750 XH	175,00	4445,00	200				

**auf
Anfrage
on
request**

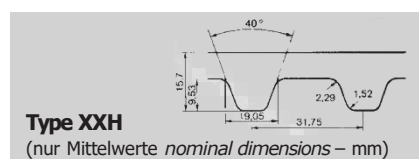

Type XXH – Teilung *pitch* 31,75 mm

Artikel- Bezeichnung <i>Designation</i>	Wirklänge <i>Pitch length</i>		Anzahl der Zähne <i>Number of teeth</i>	2" Breite <i>width</i> ≈ 50,8 mm Code-No. 200	3" Breite <i>width</i> ≈ 76,2 mm Code-No. 300	4" Breite <i>width</i> ≈ 101,6 mm Code-No. 400	5" Breite <i>width</i> ≈ 127 mm Code-No. 500
	(Zoll <i>inch</i>)	(mm)		€ Stück <i>each</i>	€ Stück <i>each</i>	€ Stück <i>each</i>	€ Stück <i>each</i>
700 XXH	70,00	1778,00	56				
800 XXH	80,00	2032,00	64				
900 XXH	90,00	2286,00	72				
1000 XXH	100,00	2540,00	80				
1200 XXH	120,00	3048,00	96				
1400 XXH	140,00	3556,00	112				
1600 XXH	160,00	4064,00	128				
1800 XXH	180,00	4572,00	144				

**auf
Anfrage
on
request**

Weitere Abmessungen auf Anfrage. *Further sizes on request.*

Bestellbeispiel *Ordering example*: 800 XXH 300

800 = Riemenlänge *Belt length* 80.0" / 2032,0 mm

XXH = Type XXH – 31,75 mm Teilung *pitch*

300 = Riemenbreite *Belt width* 3.0" / 76,2 mm

Doppel-Zahnriemen – zöllig – Chloropren Double Timing Belts – inch – Chloroprene

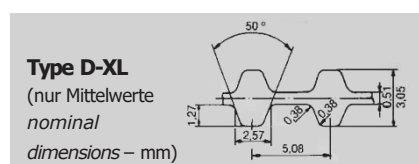

Type DXL – Teilung pitch 5,08 mm

Artikel- Bezeichnung Designation	Wirklänge Pitch length		Anzahl der Zähne Number of teeth	1/4" Breite width ≈ 6,35 mm Code-No. 025	5/16" Breite width ≈ 7,94 mm Code-No. 031	3/8" Breite width ≈ 9,53 mm Code-No. 037
	(Zoll inch)	(mm)		€ Stück each	€ Stück each	€ Stück each
150 DXL	15,00	381,00	75			
160 DXL	16,00	406,40	80			
170 DXL	17,00	431,80	85			
180 DXL	18,00	457,20	90			
190 DXL	19,00	482,60	95			
200 DXL	20,00	508,00	100			
210 DXL	21,00	533,40	105			
220 DXL	22,00	558,80	110			
230 DXL	23,00	584,20	115			
240 DXL	24,00	609,60	120			
250 DXL	25,00	635,00	125			
260 DXL	26,00	660,40	130			
280 DXL	28,00	711,20	140			
300 DXL	30,00	762,00	150			
310 DXL	31,00	787,40	155			

**auf
Anfrage
on
request**

Weitere Abmessungen auf Anfrage. Further sizes on request.

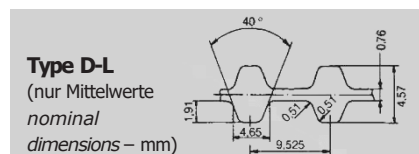

Type DL – Teilung pitch 9,525 mm

Artikel- Bezeichnung Designation	Wirklänge Pitch length		Anzahl der Zähne Number of teeth	1/2" Breite width ≈ 12,7 mm Code-No. 050	3/4" Breite width ≈ 19,05 mm Code-No. 075	1" Breite width ≈ 25,4 mm Code-No. 100
	(Zoll inch)	(mm)		€ Stück each	€ Stück each	€ Stück each
187 DL	18,75	476,25	50			
210 DL	21,00	533,40	56			
225 DL	22,50	571,50	60			
240 DL	24,00	609,60	64			
255 DL	25,50	647,70	68			
270 DL	27,00	685,80	72			
285 DL	28,50	723,90	76			
300 DL	30,00	762,00	80			
322 DL	32,25	819,15	86			
345 DL	34,50	876,30	92			
367 DL	36,75	933,45	98			
390 DL	39,00	990,60	104			
420 DL	42,00	1066,80	112			
450 DL	45,00	1143,00	120			
480 DL	48,00	1219,20	128			
510 DL	51,00	1295,40	136			
540 DL	54,00	1371,60	144			
600 DL	60,00	1524,00	160			

**auf
Anfrage
on
request**

Weitere Abmessungen auf Anfrage. Further sizes on request.

Doppel-Zahnriemen – zöllig – Chloropren Double Timing Belts – inch – Chloroprene

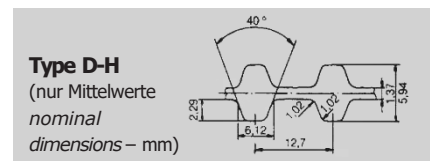

Type DH – Teilung pitch 12,7 mm

Artikel- Bezeichnung Designation	Wirklänge Pitch length		Anzahl der Zähne Number of teeth	3/4" Breite width ≈ 19,05 mm Code-No. 075	1" Breite width ≈ 25,4 mm Code-No. 100	1 1/2" Breite width ≈ 38,1 mm Code-No. 150	2" Breite width ≈ 50,8 mm Code-No. 200	3" Breite width ≈ 76,2 mm Code-No. 300
	(Zoll inch)	(mm)		€ Stück each	€ Stück each	€ Stück each	€ Stück each	€ Stück each
240 DH	24,00	609,60	48					
270 DH	27,00	685,80	54					
300 DH	30,00	762,00	60					
330 DH	33,00	838,20	66					
360 DH	36,00	914,40	72					
390 DH	39,00	990,60	78					
420 DH	42,00	1066,80	84					
450 DH	45,00	1143,00	90					
480 DH	48,00	1219,20	96					
510 DH	51,00	1295,40	102					
540 DH	54,00	1371,60	108					
570 DH	57,00	1447,80	114					
600 DH	60,00	1524,00	120					
630 DH	63,00	1600,20	126					
660 DH	66,00	1676,40	132					
700 DH	70,00	1778,00	140					
750 DH	75,00	1905,00	150					
800 DH	80,00	2032,00	160					
850 DH	85,00	2159,00	170					
900 DH	90,00	2286,00	180					
1000 DH	100,00	2540,00	200					
1100 DH	110,00	2794,00	220					
1250 DH	125,00	3175,00	250					
1400 DH	140,00	3556,00	280					
1700 DH	170,00	4318,00	340					

auf
Anfrage
on
request

Weitere Abmessungen auf Anfrage. Further sizes on request.

Zahnriemen – Chloropren Timing Belts – Chloroprene

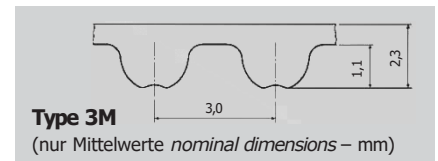

Type 3M – Teilung *pitch* 3 mm

Artikel- Bezeichnung <i>Designation</i>	Wirklänge <i>Pitch length</i> (mm)	Anzahl der Zähne <i>Number</i> of teeth	6 mm Breite <i>width</i> Code-No. 6 € Stück each	9 mm Breite <i>width</i> Code-No. 9 € Stück each	15 mm Breite <i>width</i> Code-No. 15 € Stück each
111 3M	111,00	37			
117 3M	117,00	39			
120 3M	120,00	40			
123 3M	123,00	41			
126 3M	126,00	42			
129 3M	129,00	43			
141 3M	141,00	47			
144 3M	144,00	48			
150 3M	150,00	50			
156 3M	156,00	52			
159 3M	159,00	53			
165 3M	165,00	55			
168 3M	168,00	56			
171 3M	171,00	57			
174 3M	174,00	58			
177 3M	177,00	59			
180 3M	180,00	60			
183 3M	183,00	61			
186 3M	186,00	62			
192 3M	192,00	64			
195 3M	195,00	65			
201 3M	201,00	67			
204 3M	204,00	68			
207 3M	207,00	69			
210 3M	210,00	70			
213 3M	213,00	71			
216 3M	216,00	72			
219 3M	219,00	73			
225 3M	225,00	75			
237 3M	237,00	79			
240 3M	240,00	80			
243 3M	243,00	81			
246 3M	246,00	82			
249 3M	249,00	83			
252 3M	252,00	84			
255 3M	255,00	85			
267 3M	267,00	89			
276 3M	276,00	92			
282 3M	282,00	94			
285 3M	285,00	95			
288 3M	288,00	96			
291 3M	291,00	97			
294 3M	294,00	98			
300 3M	300,00	100			
306 3M	306,00	102			
312 3M	312,00	104			
315 3M	315,00	105			
318 3M	318,00	106			
330 3M	330,00	110			
333 3M	333,00	111			

auf
Anfrage
on
request

Zahnriemen – Chloropren Timing Belts – Chloroprene

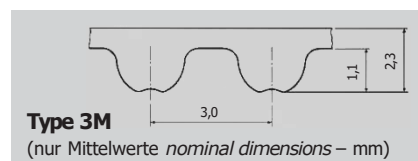

Type 3M – Teilung *pitch* 3 mm

Artikel- Bezeichnung <i>Designation</i>	Wirklänge <i>Pitch length</i> (mm)	Anzahl der Zähne <i>Number of teeth</i>	6 mm	9 mm	15 mm
			Breite <i>width</i> Code-No. 6	Breite <i>width</i> Code-No. 9	Breite <i>width</i> Code-No. 15
			€	€	€
			Stück each	Stück each	Stück each
336 3M	336,00	112			
339 3M	339,00	113			
345 3M	345,00	115			
357 3M	357,00	119			
363 3M	363,00	121			
366 3M	366,00	122			
369 3M	369,00	123			
375 3M	375,00	125			
384 3M	384,00	128			
390 3M	390,00	130			
402 3M	402,00	134			
411 3M	411,00	137			
420 3M	420,00	140			
426 3M	426,00	142			
435 3M	435,00	145			
447 3M	447,00	149			
462 3M	462,00	154			
474 3M	474,00	158			
477 3M	477,00	159			
480 3M	480,00	160			
486 3M	486,00	162			
489 3M	489,00	163			
495 3M	495,00	165			
501 3M	501,00	167			
513 3M	513,00	171			
519 3M	519,00	173			
522 3M	522,00	174			
525 3M	525,00	175			
531 3M	531,00	177			
537 3M	537,00	179			
558 3M	558,00	186			
564 3M	564,00	188			
570 3M	570,00	190			
579 3M	579,00	193			
582 3M	582,00	194			
591 3M	591,00	197			
594 3M	594,00	198			
597 3M	597,00	199			
600 3M	600,00	200			
606 3M	606,00	202			
612 3M	612,00	204			
615 3M	615,00	205			
633 3M	633,00	211			
648 3M	648,00	216			
669 3M	669,00	223			
672 3M	672,00	224			
675 3M	675,00	225			
708 3M	708,00	236			
711 3M	711,00	237			
738 3M	738,00	246			
753 3M	753,00	251			
804 3M	804,00	268			
816 3M	816,00	272			
843 3M	843,00	281			
882 3M	882,00	294			
888 3M	888,00	296			

auf
Anfrage
on
request

Weitere Abmessungen auf Anfrage. *Further sizes on request.*

Zahnriemen – Chloropren Timing Belts – Chloroprene

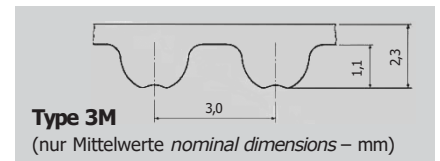

Type 3M – Teilung *pitch* 3 mm

Artikel- Bezeichnung <i>Designation</i>	Wirklänge <i>Pitch length</i> (mm)	Anzahl der Zähne <i>Number of teeth</i>	6 mm Breite <i>width</i> Code-No. 6 € Stück each	9 mm Breite <i>width</i> Code-No. 9 € Stück each	15 mm Breite <i>width</i> Code-No. 15 € Stück each
945 3M	945,00	315	auf Anfrage on request	auf Anfrage on request	auf Anfrage on request
960 3M	960,00	320			
1041 3M	1.041,00	347			
1062 3M	1.062,00	354			
1068 3M	1.068,00	356			
1071 3M	1.071,00	357			
1125 3M	1.125,00	375			
1176 3M	1.176,00	392			
1245 3M	1.245,00	415			
1263 3M	1.263,00	421			
1500 3M	1.500,00	500			
1530 3M	1.530,00	510			
1569 3M	1.569,00	523			
1587 3M	1.587,00	529			
1692 3M	1.692,00	564			
1863 3M	1.863,00	621			

Weitere Abmessungen auf Anfrage. *Further sizes on request.*

Zahnriemen – Chloropren Timing Belts – Chloroprene

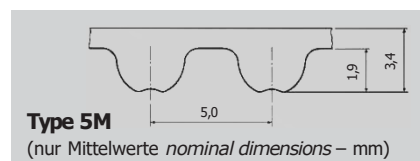

Type 5M – Teilung *pitch* 5 mm

Artikel- Bezeichnung <i>Designation</i>	Wirklänge <i>Pitch length</i> (mm)	Anzahl der Zähne <i>Number of teeth</i>	9 mm	15 mm	25 mm
			Breite <i>width</i> Code-No. 9	Breite <i>width</i> Code-No. 15	Breite <i>width</i> Code-No. 25
			€	€	€
			Stück each	Stück each	Stück each
120 5M	120,00	24			
180 5M	180,00	36			
225 5M	225,00	45			
255 5M	255,00	51			
265 5M	265,00	53			
270 5M	270,00	54			
275 5M	275,00	55			
280 5M	280,00	56			
295 5M	295,00	59			
300 5M	300,00	60			
305 5M	305,00	61			
325 5M	325,00	65			
330 5M	330,00	66			
340 5M	340,00	68			
345 5M	345,00	69			
350 5M	350,00	70			
360 5M	360,00	72			
365 5M	365,00	73			
370 5M	370,00	74			
375 5M	375,00	75			
385 5M	385,00	77			
400 5M	400,00	80			
410 5M	410,00	82			
415 5M	415,00	83			
420 5M	420,00	84			
425 5M	425,00	85			
450 5M	450,00	90			
460 5M	460,00	92			
475 5M	475,00	95			
490 5M	490,00	98			
500 5M	500,00	100			
520 5M	520,00	104			
525 5M	525,00	105			
535 5M	535,00	107			
540 5M	540,00	108			
550 5M	550,00	110			
560 5M	560,00	112			
565 5M	565,00	113			
575 5M	575,00	115			
580 5M	580,00	116			
600 5M	600,00	120			
610 5M	610,00	122			
615 5M	615,00	123			
620 5M	620,00	124			
625 5M	625,00	125			
630 5M	630,00	126			
635 5M	635,00	127			
640 5M	640,00	128			
645 5M	645,00	129			
650 5M	650,00	130			
655 5M	655,00	131			
665 5M	665,00	133			
670 5M	670,00	134			
700 5M	700,00	140			
710 5M	710,00	142			
720 5M	720,00	144			

auf
Anfrage
on
request

Zahnriemen – Chloropren Timing Belts – Chloroprene

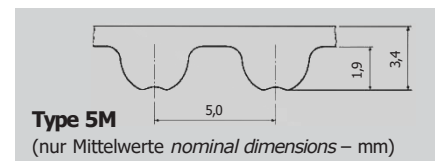

Type 5M – Teilung *pitch* 5 mm

Artikel- Bezeichnung <i>Designation</i>	Wirklänge <i>Pitch length</i> (mm)	Anzahl der Zähne <i>Number of teeth</i>	9 mm	15 mm	25 mm
			Breite <i>width</i> Code-No. 9	Breite <i>width</i> Code-No. 15	Breite <i>width</i> Code-No. 25
			€ Stück <i>each</i>	€ Stück <i>each</i>	€ Stück <i>each</i>
740 5M	740,00	148			
745 5M	745,00	149			
750 5M	750,00	150			
755 5M	755,00	151			
775 5M	775,00	155			
790 5M	790,00	158			
800 5M	800,00	160			
810 5M	810,00	162			
825 5M	825,00	165			
830 5M	830,00	166			
835 5M	835,00	167			
845 5M	845,00	169			
850 5M	850,00	170			
860 5M	860,00	172			
870 5M	870,00	174			
890 5M	890,00	178			
900 5M	900,00	180			
920 5M	920,00	184			
925 5M	925,00	185			
935 5M	935,00	187			
940 5M	940,00	188			
950 5M	950,00	190			
960 5M	960,00	192			
965 5M	965,00	193			
975 5M	975,00	195			
980 5M	980,00	196			
985 5M	985,00	197			
1000 5M	1.000,00	200			
1025 5M	1.025,00	205			
1035 5M	1.035,00	207			
1050 5M	1.050,00	210			
1080 5M	1.080,00	216			
1100 5M	1.100,00	220			
1125 5M	1.125,00	225			
1135 5M	1.135,00	227			
1200 5M	1.200,00	240			
1270 5M	1.270,00	254			
1350 5M	1.350,00	270			
1380 5M	1.380,00	276			
1400 5M	1.400,00	280			
1420 5M	1.420,00	284			
1425 5M	1.425,00	285			
1500 5M	1.500,00	300			
1595 5M	1.595,00	319			
1690 5M	1.690,00	338			
1790 5M	1.790,00	358			
1800 5M	1.800,00	360			
1870 5M	1.870,00	374			
1895 5M	1.895,00	379			
1910 5M	1.910,00	382			
2000 5M	2.000,00	400			
2110 5M	2.110,00	422			
2250 5M	2.250,00	450			
2350 5M	2.350,00	470			
2525 5M	2.525,00	505			

auf
Anfrage
on
request

Weitere Abmessungen auf Anfrage. *Further sizes on request.*

Zahnriemen – Chloropren Timing Belts – Chloroprene

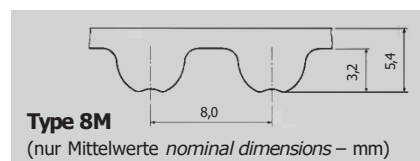

Type 8M – Teilung *pitch* 8 mm

Artikel- Bezeichnung <i>Designation</i>	Wirklänge <i>Pitch length</i> (mm)	Anzahl der Zähne <i>Number of teeth</i>	20 mm	30 mm	50 mm	85 mm
			Breite <i>width</i> Code-No. 20	Breite <i>width</i> Code-No. 30	Breite <i>width</i> Code-No. 50	Breite <i>width</i> Code-No. 85
			€	€	€	€
			Stück each	Stück each	Stück each	Stück each
288 8M	288,00	36				
320 8M	320,00	40				
376 8M	376,00	47				
416 8M	416,00	52				
424 8M	424,00	53				
440 8M	440,00	55				
480 8M	480,00	60				
512 8M	512,00	64				
520 8M	520,00	65				
536 8M	536,00	67				
560 8M	560,00	70				
576 8M	576,00	72				
584 8M	584,00	73				
600 8M	600,00	75				
608 8M	608,00	76				
624 8M	624,00	78				
632 8M	632,00	79				
640 8M	640,00	80				
656 8M	656,00	82				
672 8M	672,00	84				
680 8M	680,00	85				
712 8M	712,00	89				
720 8M	720,00	90				
744 8M	744,00	93				
760 8M	760,00	95				
776 8M	776,00	97				
784 8M	784,00	98				
792 8M	792,00	99				
800 8M	800,00	100				
824 8M	824,00	103				
840 8M	840,00	105				
848 8M	848,00	106				
856 8M	856,00	107				
880 8M	880,00	110				
896 8M	896,00	112				
912 8M	912,00	114				
920 8M	920,00	115				
936 8M	936,00	117				
960 8M	960,00	120				
968 8M	968,00	121				
976 8M	976,00	122				
1000 8M	1.000,00	125				
1040 8M	1.040,00	130				
1056 8M	1.056,00	132				
1064 8M	1.064,00	133				
1080 8M	1.080,00	135				
1096 8M	1.096,00	137				
1120 8M	1.120,00	140				
1128 8M	1.128,00	141				
1152 8M	1.152,00	144				
1160 8M	1.160,00	145				
1168 8M	1.168,00	146				
1184 8M	1.184,00	148				
1192 8M	1.192,00	149				
1200 8M	1.200,00	150				
1216 8M	1.216,00	152				

auf
Anfrage
on
request

Weitere Abmessungen auf Anfrage. *Further sizes on request.*

Zahnriemen – Chloropren Timing Belts – Chloroprene

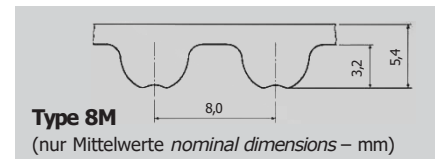

Type 8M – Teilung *pitch* 8 mm

Artikel- Bezeichnung <i>Designation</i>	Wirklänge <i>Pitch length</i> (mm)	Anzahl der Zähne <i>Number</i> of teeth	20 mm Breite <i>width</i> Code-No. 20	30 mm Breite <i>width</i> Code-No. 30	50 mm Breite <i>width</i> Code-No. 50	85 mm Breite <i>width</i> Code-No. 85
			€ Stück <i>each</i>	€ Stück <i>each</i>	€ Stück <i>each</i>	€ Stück <i>each</i>
1224 8M	1.224,00	153				
1248 8M	1.248,00	156				
1256 8M	1.256,00	157				
1264 8M	1.264,00	158				
1280 8M	1.280,00	160				
1296 8M	1.296,00	162				
1304 8M	1.304,00	163				
1328 8M	1.328,00	166				
1344 8M	1.344,00	168				
1360 8M	1.360,00	170				
1392 8M	1.392,00	174				
1400 8M	1.400,00	175				
1424 8M	1.424,00	178				
1440 8M	1.440,00	180				
1520 8M	1.520,00	190				
1552 8M	1.552,00	194				
1584 8M	1.584,00	198				
1600 8M	1.600,00	200				
1680 8M	1.680,00	210				
1696 8M	1.696,00	212				
1728 8M	1.728,00	216				
1760 8M	1.760,00	220				
1800 8M	1.800,00	225				
1896 8M	1.896,00	237				
1904 8M	1.904,00	238				
1936 8M	1.936,00	242				
2000 8M	2.000,00	250				
2080 8M	2.080,00	260				
2104 8M	2.104,00	263				
2240 8M	2.240,00	280				
2248 8M	2.248,00	281				
2272 8M	2.272,00	284				
2400 8M	2.400,00	300				
2504 8M	2.504,00	313				
2600 8M	2.600,00	325				
2800 8M	2.800,00	350				
3048 8M	3.048,00	381				
3280 8M	3.280,00	410				
3600 8M	3.600,00	450				
4400 8M	4.400,00	550				

auf
Anfrage
on
request

Zahnriemen – Chloropren Timing Belts – Chloroprene

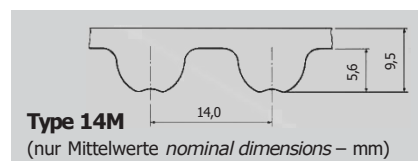

Type 14M – Teilung pitch 14 mm

Artikel- Bezeichnung <i>Designation</i>	Wirklänge <i>Pitch length</i> (mm)	Anzahl der Zähne <i>Number of teeth</i>	40 mm	55 mm	85 mm	115 mm	170 mm
			Breite <i>width</i> Code-No. 40 € Stück each	Breite <i>width</i> Code-No. 55 € Stück each	Breite <i>width</i> Code-No. 85 € Stück each	Breite <i>width</i> Code-No. 115 € Stück each	Breite <i>width</i> Code-No. 170 € Stück each
966 14M	966,00	69					
1092 14M	1092,00	78					
1190 14M	1190,00	85					
1344 14M	1344,00	96					
1400 14M	1400,00	100					
1456 14M	1456,00	104					
1512 14M	1512,00	108					
1540 14M	1540,00	110					
1610 14M	1610,00	115					
1680 14M	1680,00	120					
1778 14M	1778,00	127					
1890 14M	1890,00	135					
2100 14M	2100,00	150					
2310 14M	2310,00	165					
2450 14M	2450,00	175					
2590 14M	2590,00	185					
2800 14M	2800,00	200					
3150 14M	3150,00	225					
3360 14M	3360,00	240					
3500 14M	3500,00	250					
3850 14M	3850,00	275					
4004 14M	4004,00	286					
4326 14M	4326,00	309					
4578 14M	4578,00	327					

auf
Anfrage
on
request

Type 20M – Teilung pitch 20 mm

Artikel- Bezeichnung <i>Designation</i>	Wirklänge <i>Pitch length</i> (mm)	Anzahl der Zähne <i>Number of teeth</i>	115 mm	170 mm	230 mm	290 mm	340 mm
			Breite <i>width</i> Code-No. 115 € Stück each	Breite <i>width</i> Code-No. 170 € Stück each	Breite <i>width</i> Code-No. 230 € Stück each	Breite <i>width</i> Code-No. 290 € Stück each	Breite <i>width</i> Code-No. 340 € Stück each
2000 20M	2000,00	100					
2500 20M	2500,00	125					
3400 20M	3400,00	170					
3800 20M	3800,00	190					
4200 20M	4200,00	210					
4600 20M	4600,00	230					
5000 20M	5000,00	250					
5200 20M	5200,00	260					
5400 20M	5400,00	270					
5600 20M	5600,00	280					
5800 20M	5800,00	290					
6000 20M	6000,00	300					
6200 20M	6200,00	310					
6400 20M	6400,00	320					
6600 20M	6600,00	330					

auf
Anfrage
on
request

Weitere Abmessungen auf Anfrage. Further sizes on request.

PRODUKTINFORMATION

Gliewe Power Plus Zahnflachriemen

Leistungsvergleich

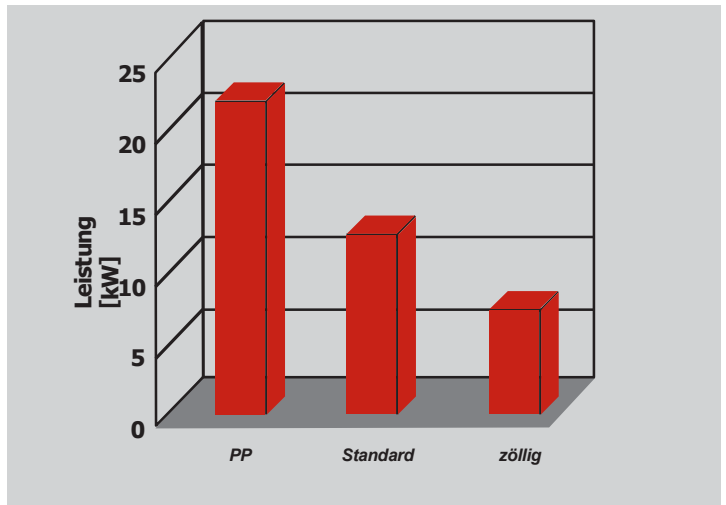

Serienmäßige Eigenschaften:

- Ölbeständigkeit
verhindert den schädigenden Einfluss von Mineralölen und Fetten
- Temperaturbeständigkeit
keine frühzeitige Alterung und Versprödung
- Elektrische Leitfähigkeit
Prüfung nach ISO 9563
- Geräuschemission
neu entwickelte Werkstoffe
- Lebensdauer
18fach höhere Laufzeiten
- Wirkungsgrad
nahezu reibungsfreier Antrieb

Vorteile:

- geeignet für schnell laufende, hoch belastete Antriebe
- geringe Lagerbelastung
- temperaturbeständig von -30 °C bis +100 °C
- geringe Geräuscheentwicklung
- Reduzierung der Baugrößen, dadurch Kosteneinsparung
- wartungsfrei

Anwendungsbeispiele

Hohe Leistung	Hohes Drehmoment	Geräuschreduzierung	Geringes Zahnlückenspiel
Ersatz für Trapezprofile	Förderanlagen	Werkzeugmaschinen	Lineareinheiten
Kompakte Bauweise	Gartengeräte	Haushaltsmaschinen	Roboter
Textilmaschinen	Druckmaschinen	Textilmaschinen	Druckmaschinen
Papiermaschinen	Textilmaschinen	Druckmaschinen	Büromaschinen
Hydraulikpumpen	Papiermühlen	Förderanlagen	Handhabungsautomaten
Holzverarbeitung	Extruder	Ersatz für Kette	Werkzeugmaschinen

**Für weitere Rückfragen stehen wir Ihnen gern zur Verfügung.
Rufen Sie uns einfach an oder mailen Sie uns. Wir sind für Sie da!**

Hochleistungs-Zahnriemen – Chloropren

High Performance Timing Belts – Chloroprene

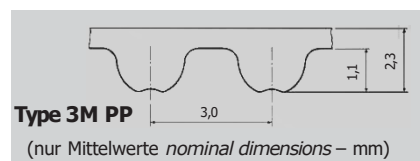

Type 3M PP – Teilung *pitch* 3 mm

Artikel- Bezeichnung <i>Designation</i>	Wirklänge <i>Pitch length</i> (mm)	Anzahl der Zähne <i>Number of teeth</i>	6 mm Breite <i>width</i> Code-No. 6 € Stück each	9 mm Breite <i>width</i> Code-No. 9 € Stück each	15 mm Breite <i>width</i> Code-No. 15 € Stück each
111 3MPP	111,00	37			
129 3MPP	129,00	43			
141 3MPP	141,00	47			
144 3MPP	144,00	48			
150 3MPP	150,00	50			
159 3MPP	159,00	53			
165 3MPP	165,00	55			
168 3MPP	168,00	56			
171 3MPP	171,00	57			
174 3MPP	174,00	58			
177 3MPP	177,00	59			
180 3MPP	180,00	60			
183 3MPP	183,00	61			
186 3MPP	186,00	62			
192 3MPP	192,00	64			
195 3MPP	195,00	65			
201 3MPP	201,00	67			
204 3MPP	204,00	68			
207 3MPP	207,00	69			
210 3MPP	210,00	70			
213 3MPP	213,00	71			
219 3MPP	219,00	73			
225 3MPP	225,00	75			
237 3MPP	237,00	79			
240 3MPP	240,00	80			
246 3MPP	246,00	82			
249 3MPP	249,00	83			
252 3MPP	252,00	84			
255 3MPP	255,00	85			
267 3MPP	267,00	89			
276 3MPP	276,00	92			
282 3MPP	282,00	94			
285 3MPP	285,00	95			
288 3MPP	288,00	96			
291 3MPP	291,00	97			
294 3MPP	294,00	98			
300 3MPP	300,00	100			
312 3MPP	312,00	104			
315 3MPP	315,00	105			
318 3MPP	318,00	106			
330 3MPP	330,00	110			
333 3MPP	333,00	111			
336 3MPP	336,00	112			
339 3MPP	339,00	113			
345 3MPP	345,00	115			
357 3MPP	357,00	119			
363 3MPP	363,00	121			
366 3MPP	366,00	122			
375 3MPP	375,00	125			
384 3MPP	384,00	128			
390 3MPP	390,00	130			
420 3MPP	420,00	140			
426 3MPP	426,00	142			
435 3MPP	435,00	145			
447 3MPP	447,00	149			
462 3MPP	462,00	154			

Weitere
Größen
auf
Anfrage
on
request

Hochleistungs-Zahnriemen – Chloropren

High Performance Timing Belts – Chloroprene

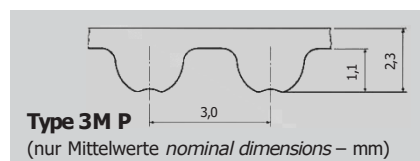

Type 3M P – Teilung *pitch* 3 mm

Artikel- Bezeichnung <i>Designation</i>	Wirklänge <i>Pitch length</i> (mm)	Anzahl der Zähne <i>Number</i> of teeth	6 mm Breite <i>width</i> Code-No. 6 € Stück each	9 mm Breite <i>width</i> Code-No. 9 € Stück each	15 mm Breite <i>width</i> Code-No. 15 € Stück each
474 3MPP	474,00	158			
480 3MPP	480,00	160			
486 3MPP	486,00	162			
495 3MPP	495,00	165			
501 3MPP	501,00	167			
513 3MPP	513,00	171			
519 3MPP	519,00	173			
522 3MPP	522,00	174			
525 3MPP	525,00	175			
531 3MPP	531,00	177			
537 3MPP	537,00	179			
558 3MPP	558,00	186			
564 3MPP	564,00	188			
570 3MPP	570,00	190			
582 3MPP	582,00	194			
597 3MPP	597,00	199			
600 3MPP	600,00	200			
606 3MPP	606,00	202			
615 3MPP	615,00	205			
633 3MPP	633,00	211			
669 3MPP	669,00	223			
675 3MPP	675,00	225			
711 3MPP	711,00	237			
738 3MPP	738,00	246			
804 3MPP	804,00	268			
816 3MPP	816,00	272			
843 3MPP	843,00	281			
882 3MPP	882,00	294			
888 3MPP	888,00	296			
1062 3MPP	1.062,00	354			
1569 3MPP	1.569,00	523			
1587 3MPP	1.587,00	529			
1692 3MPP	1.692,00	564			

**weitere
Größen
auf
Anfrage
on
request**

Weitere Abmessungen auf Anfrage. Further sizes on request.

Hochleistungs-Zahnriemen – Chloropren

High Performance Timing Belts – Chloroprene

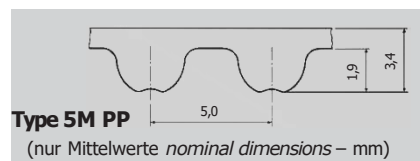

Type 5M PP – Teilung *pitch* 5 mm

Artikel- Bezeichnung <i>Designation</i>	Wirklänge <i>Pitch length</i> (mm)	Anzahl der Zähne <i>Number of teeth</i>	9 mm Breite <i>width</i> Code-No. 9 € Stück <i>each</i>	15 mm Breite <i>width</i> Code-No. 15 € Stück <i>each</i>	25 mm Breite <i>width</i> Code-No. 25 € Stück <i>each</i>
180 5MPP	180,00	36			
225 5MPP	225,00	45			
255 5MPP	255,00	51			
265 5MPP	265,00	53			
270 5MPP	270,00	54			
275 5MPP	275,00	55			
280 5MPP	280,00	56			
295 5MPP	295,00	59			
300 5MPP	300,00	60			
305 5MPP	305,00	61			
325 5MPP	325,00	65			
330 5MPP	330,00	66			
340 5MPP	340,00	68			
350 5MPP	350,00	70			
360 5MPP	360,00	72			
365 5MPP	365,00	73			
370 5MPP	370,00	74			
375 5MPP	375,00	75			
385 5MPP	385,00	77			
400 5MPP	400,00	80			
415 5MPP	415,00	83			
420 5MPP	420,00	84			
425 5MPP	425,00	85			
450 5MPP	450,00	90			
460 5MPP	460,00	92			
475 5MPP	475,00	95			
490 5MPP	490,00	98			
500 5MPP	500,00	100			
520 5MPP	520,00	104			
525 5MPP	525,00	105			
535 5MPP	535,00	107			
540 5MPP	540,00	108			
550 5MPP	550,00	110			
560 5MPP	560,00	112			
565 5MPP	565,00	113			
575 5MPP	575,00	115			
580 5MPP	580,00	116			
600 5MPP	600,00	120			
610 5MPP	610,00	122			
615 5MPP	615,00	123			
630 5MPP	630,00	126			
635 5MPP	635,00	127			
640 5MPP	640,00	128			
645 5MPP	645,00	129			
650 5MPP	650,00	130			
665 5MPP	665,00	133			
670 5MPP	670,00	134			
700 5MPP	700,00	140			
710 5MPP	710,00	142			
720 5MPP	720,00	144			
740 5MPP	740,00	148			
750 5MPP	750,00	150			
755 5MPP	755,00	151			
775 5MPP	775,00	155			
790 5MPP	790,00	158			
800 5MPP	800,00	160			

Weitere
Größen
auf
Anfrage
on
request

Hochleistungs-Zahnriemen – Chloropren

High Performance Timing Belts – Chloroprene

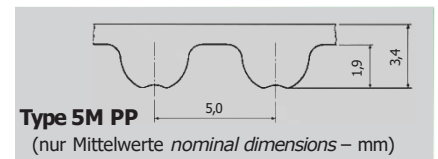

Type 5M PP – Teilung pitch 5 mm

Artikel- Bezeichnung Designation	Wirklänge Pitch length (mm)	Anzahl der Zähne Number of teeth	9 mm	15 mm	25 mm
			Breite width Code-No. 9	Breite width Code-No. 15	Breite width Code-No. 25
			€	€	€
			Stück each	Stück each	Stück each
825 5MPP	825,00	165			
830 5MPP	830,00	166			
835 5MPP	835,00	167			
850 5MPP	850,00	170			
860 5MPP	860,00	172			
890 5MPP	890,00	178			
900 5MPP	900,00	180			
925 5MPP	925,00	185			
935 5MPP	935,00	187			
940 5MPP	940,00	188			
950 5MPP	950,00	190			
965 5MPP	965,00	193			
975 5MPP	975,00	195			
980 5MPP	980,00	196			
1000 5MPP	1000,00	200			
1025 5MPP	1025,00	205			
1035 5MPP	1035,00	207			
1050 5MPP	1050,00	210			
1100 5MPP	1100,00	220			
1125 5MPP	1125,00	225			
1135 5MPP	1135,00	227			
1200 5MPP	1200,00	240			
1270 5MPP	1270,00	254			
1380 5MPP	1380,00	276			
1400 5MPP	1400,00	280			
1420 5MPP	1420,00	284			
1425 5MPP	1425,00	285			
1500 5MPP	1500,00	300			
1595 5MPP	1595,00	319			
1690 5MPP	1690,00	338			
1790 5MPP	1790,00	358			
1870 5MPP	1870,00	374			
1895 5MPP	1895,00	379			
2000 5MPP	2000,00	400			
2110 5MPP	2110,00	422			
2350 5MPP	2350,00	470			
2525 5MPP	2525,00	505			

**Weitere
Größen
auf
Anfrage
on
request**

Weitere Abmessungen auf Anfrage. Further sizes on request.

Hochleistungs-Zahnriemen – Chloropren

High Performance Timing Belts – Chloroprene

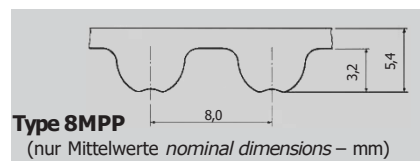

Type 8M PP – Teilung *pitch* 8 mm

Artikel- Bezeichnung <i>Designation</i>	Wirklänge <i>Pitch length</i> (mm)	Anzahl der Zähne <i>Number of teeth</i>	20 mm	30 mm	50 mm	85 mm
			Breite <i>width</i> Code-No. 20	Breite <i>width</i> Code-No. 30	Breite <i>width</i> Code-No. 50	Breite <i>width</i> Code-No. 85
			€	€	€	€
			Stück each	Stück each	Stück each	Stück each
288 8MPP	288,00	36				
352 8MPP	352,00	44				
376 8MPP	376,00	47				
416 8MPP	416,00	52				
424 8MPP	424,00	53				
480 8MPP	480,00	60				
512 8MPP	512,00	64				
520 8MPP	520,00	65				
536 8MPP	536,00	67				
560 8MPP	560,00	70				
576 8MPP	576,00	72				
584 8MPP	584,00	73				
600 8MPP	600,00	75				
608 8MHP	608,00	76				
624 8MPP	624,00	78				
632 8MPP	632,00	79				
640 8MPP	640,00	80				
656 8MPP	656,00	82				
680 8MPP	680,00	85				
712 8MPP	712,00	89				
720 8MPP	720,00	90				
760 8MPP	760,00	95				
776 8MPP	776,00	97				
784 8MPP	784,00	98				
800 8MPP	800,00	100				
824 8MPP	824,00	103				
840 8MPP	840,00	105				
848 8MPP	848,00	106				
856 8MPP	856,00	107				
880 8MPP	880,00	110				
896 8MPP	896,00	112				
912 8MPP	912,00	114				
920 8MPP	920,00	115				
960 8MPP	960,00	120				
976 8MPP	976,00	122				
1000 8MPP	1.000,00	125				
1040 8MPP	1.040,00	130				
1056 8MPP	1.056,00	132				
1064 8MPP	1.064,00	133				
1080 8MPP	1.080,00	135				
1096 8MPP	1.096,00	137				
1120 8MPP	1.120,00	140				
1128 8MPP	1.128,00	141				
1160 8MPP	1.160,00	145				
1184 8MPP	1.184,00	148				
1200 8MPP	1.200,00	150				
1216 8MPP	1.216,00	152				
1224 8MPP	1.224,00	153				
1248 8MPP	1.248,00	156				
1256 8MPP	1.256,00	157				
1264 8MPP	1.264,00	158				
1280 8MPP	1.280,00	160				
1304 8MPP	1.304,00	163				
1320 8MPP	1.320,00	165				
1328 8MPP	1.328,00	166				
1344 8MPP	1.344,00	168				

**Weitere
Größen
auf
Anfrage
on
request**

Hochleistungs-Zahnriemen – Chloropren

High Performance Timing Belts – Chloroprene

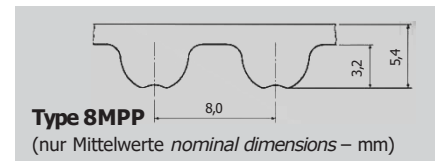

Type 8M PP – Teilung *pitch* 8 mm

1360 8MPP	1.360,00	170
1400 8MPP	1.400,00	175
1424 8MPP	1.424,00	178
1440 8MPP	1.440,00	180
1480 8MPP	1.480,00	185
1520 8MPP	1.520,00	190
1552 8MPP	1.552,00	194
1584 8MPP	1.584,00	198
1600 8MPP	1.600,00	200
1680 8MPP	1.680,00	210
1696 8MPP	1.696,00	212
1728 8MPP	1.728,00	216
1760 8MPP	1.760,00	220
1800 8MPP	1.800,00	225
1896 8MPP	1.896,00	237
1904 8MPP	1.904,00	238
1936 8MPP	1.936,00	242
2000 8MPP	2.000,00	250
2080 8MPP	2.080,00	260
2104 8MPP	2.104,00	263
2240 8MPP	2.240,00	280
2248 8MPP	2.248,00	281
2272 8MPP	2.272,00	284
2400 8MPP	2.400,00	300
2504 8MPP	2.504,00	313
2600 8MPP	2.600,00	325
2800 8MPP	2.800,00	350
3048 8MPP	3.048,00	381
3280 8MPP	3.280,00	410
3600 8MPP	3.600,00	450

**Weitere
Größen
auf
Anfrage
on
request**

Weitere Abmessungen auf Anfrage. Further sizes on request.

Hochleistungs-Zahnriemen – Chloropren

High Performance Timing Belts – Chloroprene

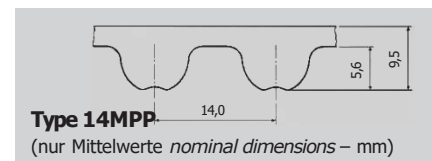

Type 14M PP – Teilung *pitch* 14 mm

Artikel- Bezeichnung <i>Designation</i>	Wirklänge <i>Pitch length</i> (mm)	Anzahl der Zähne <i>Number of teeth</i>	40 mm	55 mm	85 mm	115 mm	170 mm
			Breite <i>width</i> Code-No. 40	Breite <i>width</i> Code-No. 55	Breite <i>width</i> Code-No. 85	Breite <i>width</i> Code-No. 115	Breite <i>width</i> Code-No. 170
			€ Stück <i>each</i>	€ Stück <i>each</i>	€ Stück <i>each</i>	€ Stück <i>each</i>	€ Stück <i>each</i>
966 14MPP	966,00	69					
1092 14MPP	1092,00	78					
1190 14MPP	1190,00	85					
1344 14MPP	1344,00	96					
1400 14MPP	1400,00	100					
1456 14MPP	1456,00	104					
1512 14MPP	1512,00	108					
1540 14MPP	1540,00	110					
1610 14MPP	1610,00	115					
1680 14MPP	1680,00	120					
1778 14MPP	1778,00	127					
1890 14MPP	1890,00	135					
2100 14MPP	2100,00	150					
2310 14MPP	2310,00	165					
2450 14MPP	2450,00	175					
2590 14MPP	2590,00	185					
2800 14MPP	2800,00	200					
3150 14MPP	3150,00	225					
3360 14MPP	3360,00	240					
3500 14MPP	3500,00	250					
3850 14MPP	3850,00	275					
4326 14MPP	4326,00	309					
4578 14MPP	4578,00	327					

**Weitere
Größen
auf
Anfrage
on
request**

Weitere Abmessungen auf Anfrage. Further sizes on request.

Doppel-Zahnriemen – M – Chloropren

Double Timing Belts – M – Chloroprene

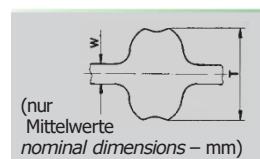

Type	D5M
W	1,143
T	5,258

Type D5M – Teilung *pitch* 5 mm

Artikel- Bezeichnung Designation	Wirklänge Pitch length (mm)	Anzahl der Zähne Number of teeth	9 mm	15 mm	25 mm
			Breite <i>width</i> Code-No. 9	Breite <i>width</i> Code-No. 15	Breite <i>width</i> Code-No. 25
			€	€	€
			Stück each	Stück each	Stück each
565 D5M	565,00	113			
600 D5M	600,00	120			
610 D5M	615,00	122			
615 D5M	615,00	123			
630 D5M	630,00	126			
635 D5M	635,00	127			
640 D5M	640,00	128			
665 D5M	665,00	133			
670 D5M	670,00	134			
675 D5M	675,00	135			
700 D5M	700,00	140			
705 D5M	705,00	141			
710 D5M	710,00	142			
725 D5M	725,00	145			
740 D5M	740,00	148			
750 D5M	750,00	150			
755 D5M	755,00	151			
800 D5M	800,00	160			
835 D5M	835,00	167			
850 D5M	850,00	170			
890 D5M	890,00	178			
900 D5M	900,00	180			
935 D5M	935,00	187			
940 D5M	940,00	188			
950 D5M	950,00	190			
980 D5M	980,00	196			
1000 D5M	1000,00	200			
1025 D5M	1025,00	205			
1050 D5M	1050,00	210			
1100 D5M	1100,00	220			
1125 D5M	1125,00	225			
1135 D5M	1135,00	227			
1195 D5M	1195,00	239			
1200 D5M	1200,00	240			
1240 D5M	1240,00	248			
1270 D5M	1270,00	254			
1420 D5M	1420,00	284			
1500 D5M	1500,00	300			
1595 D5M	1595,00	319			
1605 D5M	1605,00	321			
1690 D5M	1690,00	338			
1790 D5M	1790,00	358			
1800 D5M	1800,00	360			
1870 D5M	1870,00	374			
1895 D5M	1895,00	379			
1945 D5M	1945,00	389			
2000 D5M	2000,00	400			
2250 D5M	2250,00	450			
2525 D5M	2525,00	505			

auf
Anfrage
on
request

Doppel-Zahnriemen – M – Chloropren

Double Timing Belts – M – Chloroprene

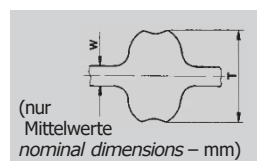

Type	D8M
W	1,372
T	8,280

Type D8M – Teilung pitch 8 mm

Artikel- Bezeichnung Designation	Wirklänge Pitch length (mm)	Anzahl der Zähne Number of teeth	20 mm	30 mm	50 mm	85 mm
			Breite width Code-No. 20	Breite width Code-No. 30	Breite width Code-No. 50	Breite width Code-No. 85
			€	€	€	€
			Stück each	Stück each	Stück each	Stück each
600 D8M	600,00	75				
608 D8M	608,00	76				
632 D8M	632,00	79				
640 D8M	640,00	80				
656 D8M	656,00	82				
680 D8M	680,00	85				
720 D8M	720,00	90				
776 D8M	776,00	97				
784 D8M	784,00	98				
800 D8M	800,00	100				
840 D8M	840,00	105				
880 D8M	880,00	110				
896 D8M	896,00	112				
920 D8M	920,00	115				
960 D8M	960,00	120				
1000 D8M	1000,00	125				
1040 D8M	1040,00	130				
1080 D8M	1080,00	135				
1120 D8M	1120,00	140				
1128 D8M	1128,00	141				
1160 D8M	1160,00	145				
1184 D8M	1184,00	148				
1200 D8M	1200,00	150				
1224 D8M	1224,00	153				
1248 D8M	1248,00	156				
1256 D8M	1256,00	157				
1264 D8M	1264,00	158				
1280 D8M	1280,00	160				
1304 D8M	1304,00	163				
1328 D8M	1328,00	166				
1344 D8M	1344,00	168				
1360 D8M	1360,00	170				
1400 D8M	1400,00	175				
1424 D8M	1424,00	178				
1440 D8M	1440,00	180				
1464 D8M	1464,00	183				
1520 D8M	1520,00	190				
1552 D8M	1552,00	194				
1584 D8M	1584,00	198				
1600 D8M	1600,00	200				
1680 D8M	1680,00	210				
1696 D8M	1696,00	212				
1728 D8M	1728,00	216				
1760 D8M	1760,00	220				
1800 D8M	1800,00	225				
1904 D8M	1904,00	238				
1936 D8M	1936,00	242				
2000 D8M	2000,00	250				
2080 D8M	2080,00	260				
2104 D8M	2104,00	263				
2200 D8M	2200,00	275				
2240 D8M	2240,00	280				
2272 D8M	2272,00	284				
2400 D8M	2400,00	300				
2504 D8M	2504,00	313				

auf
Anfrage
on
request

Doppel-Zahnriemen – M – Chloropren

Double Timing Belts – M – Chloroprene

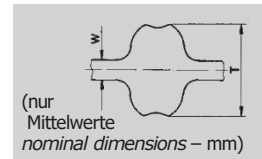

Type	D14M
W	2,794
T	14,834

Type D8M – Teilung *pitch* 8 mm

Artikel- Bezeichnung Designation	Wirklänge Pitch length (mm)	Anzahl der Zähne Number of teeth	20 mm Breite width Code-No. 20 € Stück each	30 mm Breite width Code-No. 30 € Stück each	50 mm Breite width Code-No. 50 € Stück each	85 mm Breite width Code-No. 85 € Stück each
2520 D8M	2520,00	315				
2600 D8M	2600,00	325				
2800 D8M	2800,00	350				
3048 D8M	3048,00	381				
3280 D8M	3280,00	410				
3600 D8M	3600,00	450				
4000 D8M	4000,00	550				
auf Anfrage on request						

Type D14M – Teilung *pitch* 14 mm

Artikel- Bezeichnung Designation	Wirklänge Pitch length (mm)	Anzahl der Zähne Number of teeth	40 mm Breite width Code-No. 40 € Stück each	55 mm Breite width Code-No. 55 € Stück each	85 mm Breite width Code-No. 85 € Stück each	115 mm Breite width Code-No. 115 € Stück each	170 mm Breite width Code-No. 170 € Stück each
966 D14M	966,00	69					
994 D14M	994,00	71					
1092 D14M	1092,00	78					
1106 D14M	1106,00	79					
1190 D14M	1190,00	85					
1260 D14M	1260,00	90					
1288 D14M	1288,00	92					
1344 D14M	1344,00	96					
1400 D14M	1400,00	100					
1442 D14M	1442,00	103					
1568 D14M	1568,00	112					
1610 D14M	1610,00	115					
1750 D14M	1750,00	125					
1764 D14M	1764,00	126					
1778 D14M	1778,00	127					
1848 D14M	1848,00	132					
1890 D14M	1890,00	135					
1904 D14M	1904,00	136					
1960 D14M	1960,00	140					
2100 D14M	2100,00	150					
2240 D14M	2240,00	160					
2310 D14M	2310,00	165					
2380 D14M	2380,00	170					
2450 D14M	2450,00	175					
2590 D14M	2590,00	185					
2660 D14M	2660,00	190					
2800 D14M	2800,00	200					
2968 D14M	2968,00	212					
3150 D14M	3150,00	225					
3360 D14M	3360,00	240					
3500 D14M	3500,00	250					
3850 D14M	3850,00	275					
3920 D14M	3920,00	280					
4326 D14M	4326,00	309					
4578 D14M	4578,00	327					
4956 D14M	4956,00	354					
auf Anfrage on request							

Zahnriemen – STD – Chloropren Timing Belts – STD – Chloroprene

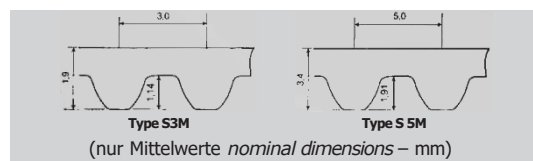

Type S3M – Teilung pitch 3 mm

Type S5M – Teilung pitch 5 mm

Artikel- Bezeichnung Designation	Wirklänge Pitch length (mm)	Anzahl der Zähne Number of teeth	Artikel- Bezeichnung Designation	Wirklänge Pitch length (mm)	Anzahl der Zähne Number of teeth
S3M 120	120,00	40	S5M 255	255,00	51
S3M 150	150,00	50	S5M 295	295,00	59
S3M 177	177,00	59	S5M 325	325,00	65
S3M 201	201,00	67	S5M 350	350,00	70
S3M 225	225,00	75	S5M 375	375,00	75
S3M 252	252,00	84	S5M 390	390,00	78
S3M 264	264,00	88	S5M 400	400,00	80
S3M 276	276,00	92	S5M 425	425,00	85
S3M 300	300,00	100	S5M 475	475,00	95
S3M 339	339,00	113	S5M 490	490,00	98
S3M 384	384,00	128	S5M 500	500,00	100
S3M 420	420,00	140	S5M 520	520,00	104
S3M 459	459,00	153	S5M 525	525,00	105
S3M 486	486,00	162	S5M 560	560,00	112
S3M 501	501,00	167	S5M 575	575,00	115
S3M 537	537,00	179	S5M 600	600,00	120
S3M 564	564,00	188	S5M 625	625,00	125
S3M 633	633,00	211	S5M 650	650,00	130
			S5M 675	675,00	135
			S5M 700	700,00	140
			S5M 750	750,00	150
			S5M 800	800,00	160
			S5M 850	850,00	170
			S5M 900	900,00	180
			S5M 950	950,00	190
			S5M 1000	1000,00	200
			S5M 1050	1050,00	210
			S5M 1125	1125,00	225
			S5M 1270	1270,00	254
			S5M 1350	1350,00	270
			S5M 1420	1420,00	284
			S5M 1800	1800,00	360
			S5M 2000	2000,00	400
Type S2M auf Anfrage <i>pitch S2M on request</i>					
Type S4,5M auf Anfrage <i>pitch S4,5M on request</i>					

Abnahmemengen sowie weitere Abmessungen auf Anfrage.
Minimum quantities and further sizes on request.

Zahnriemen – STD – Chloropren Timing Belts – STD – Chloroprene

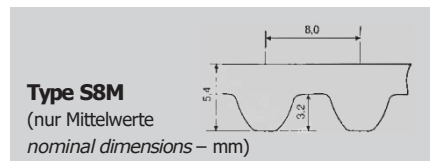

Type S8M – Teilung pitch 8 mm

Artikel- Bezeichnung Designation	Wirklänge Pitch length (mm)	Anzahl der Zähne Number of teeth	20 mm	30 mm	50 mm	85 mm
			Breite width Code-No. 200	Breite width Code-No. 300	Breite width Code-No. 500	Breite width Code-No. 850
			€ Stück each	€ Stück each	€ Stück each	€ Stück each
S8M 440	440,00	55				
S8M 480	480,00	60				
S8M 560	560,00	70				
S8M 600	600,00	75				
S8M 632	632,00	79				
S8M 640	640,00	80				
S8M 656	656,00	82				
S8M 680	680,00	85				
S8M 688	688,00	86				
S8M 696	696,00	87				
S8M 712	712,00	89				
S8M 720	720,00	90				
S8M 728	728,00	91				
S8M 736	736,00	92				
S8M 760	760,00	95				
S8M 768	768,00	96				
S8M 784	784,00	98				
S8M 792	792,00	99				
S8M 800	800,00	100				
S8M 824	824,00	103				
S8M 840	840,00	105				
S8M 848	848,00	106				
S8M 864	864,00	108				
S8M 880	880,00	110				
S8M 896	896,00	112				
S8M 912	912,00	114				
S8M 920	920,00	115				
S8M 944	944,00	118				
S8M 960	960,00	120				
S8M 992	992,00	124				
S8M 1000	1.000,00	125				
S8M 1024	1.024,00	128				
S8M 1032	1.032,00	129				
S8M 1040	1.040,00	130				
S8M 1056	1.056,00	132				
S8M 1064	1.064,00	133				
S8M 1072	1.072,00	134				
S8M 1080	1.080,00	135				
S8M 1096	1.096,00	137				
S8M 1104	1.104,00	138				
S8M 1120	1.120,00	140				
S8M 1136	1.136,00	142				
S8M 1152	1.152,00	144				
S8M 1160	1.160,00	145				
S8M 1168	1.168,00	146				
S8M 1176	1.176,00	147				
S8M 1184	1.184,00	148				
S8M 1192	1.192,00	149				
S8M 1200	1.200,00	150				
S8M 1208	1.208,00	151				
S8M 1216	1.216,00	152				
S8M 1224	1.224,00	153				
S8M 1240	1.240,00	155				
S8M 1248	1.248,00	156				
S8M 1256	1.256,00	157				
S8M 1264	1.264,00	158				

auf
Anfrage
on
request

Weitere Abmessungen auf Anfrage. Further sizes on request.

Zahnriemen – STD – Chloropren Timing Belts – STD – Chloroprene



Type S8M – Teilung *pitch* 8 mm

Artikel- Bezeichnung <i>Designation</i>	Wirklänge <i>Pitch length</i> (mm)	Anzahl der Zähne <i>Number of teeth</i>	20 mm	30 mm	50 mm	85 mm
			Breite <i>width</i> Code-No. 200	Breite <i>width</i> Code-No. 300	Breite <i>width</i> Code-No. 500	Breite <i>width</i> Code-No. 850
			€ Stück <i>each</i>	€ Stück <i>each</i>	€ Stück <i>each</i>	€ Stück <i>each</i>
S8M 1280	1.280,00	160				
S8M 1296	1.296,00	162				
S8M 1304	1.304,00	163				
S8M 1312	1.312,00	164				
S8M 1320	1.320,00	165				
S8M 1344	1.344,00	168				
S8M 1352	1.352,00	169				
S8M 1360	1.360,00	170				
S8M 1384	1.384,00	173				
S8M 1392	1.392,00	174				
S8M 1400	1.400,00	175				
S8M 1408	1.408,00	176				
S8M 1440	1.440,00	180				
S8M 1480	1.480,00	185				
S8M 1552	1.552,00	194				
S8M 1600	1.600,00	200				
S8M 1624	1.624,00	203				
S8M 1760	1.760,00	220				
S8M 1776	1.776,00	222				
S8M 1800	1.800,00	225				
S8M 1816	1.816,00	227				
S8M 1832	1.832,00	229				
S8M 1912	1.912,00	239				
S8M 2000	2.000,00	250				
S8M 2024	2.024,00	253				
S8M 2240	2.240,00	280				
S8M 2392	2.392,00	299				
S8M 2400	2.400,00	300				
S8M 2496	2.496,00	312				
S8M 2600	2.600,00	325				
S8M 2800	2.800,00	350				
S8M 3200	3.200,00	400				

**auf
Anfrage
on
request**

Type S14M – Teilung *pitch* 14 mm

Artikel- Bezeichnung <i>Designation</i>	Wirklänge <i>Pitch length</i> (mm)	Anzahl der Zähne <i>Number of teeth</i>	40 mm	55 mm	85 mm	115 mm	170 mm
			Breite <i>width</i> Code-No. 400	Breite <i>width</i> Code-No. 550	Breite <i>width</i> Code-No. 850	Breite <i>width</i> Code-No. 1150	Breite <i>width</i> Code-No. 1700
			€ Stück <i>each</i>	€ Stück <i>each</i>	€ Stück <i>each</i>	€ Stück <i>each</i>	€ Stück <i>each</i>
S14M 1400	1.400,00	100					
S14M 1540	1.540,00	110					
S14M 1610	1.610,00	115					
S14M 1890	1.890,00	135					
S14M 2002	2.002,00	143					
S14M 2100	2.100,00	150					
S14M 2240	2.240,00	160					
S14M 2310	2.310,00	165					
S14M 2450	2.450,00	175					
S14M 2590	2.590,00	185					
S14M 2800	2.800,00	200					
S14M 3150	3.150,00	225					
S14M 3500	3.500,00	250					
S14M 3850	3.850,00	275					
S14M 4004	4.004,00	286					
S14M 4508	4.508,00	322					
S14M 5012	5.012,00	358					

**auf
Anfrage
on
request**

Weitere Abmessungen auf Anfrage. Further sizes on request.

Doppel-Zahnriemen – STD – Chloropren

Double Timing Belts – STD – Chloroprene

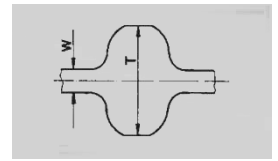

Type DS8M – Teilung *pitch* 8 mm

Artikel- Bezeichnung <i>Designation</i>	Wirklänge <i>Pitch length</i> (mm)	Anzahl der Zähne <i>Number</i> of teeth	20 mm	30 mm	50 mm	85 mm
			Breite <i>width</i> Code-No. 200	Breite <i>width</i> Code-No. 300	Breite <i>width</i> Code-No. 500	Breite <i>width</i> Code-No. 850
			€	€	€	€
			Stück <i>each</i>	Stück <i>each</i>	Stück <i>each</i>	Stück <i>each</i>
DS8M 1160	1160,00	145				
DS8M 1168	1168,00	146				
DS8M 1176	1176,00	147				
DS8M 1184	1184,00	148				
DS8M 1200	1200,00	150				
DS8M 1216	1216,00	152				
DS8M 1240	1240,00	155				
DS8M 1256	1256,00	157				
DS8M 1264	1264,00	158				
DS8M 1280	1280,00	160				
DS8M 1304	1304,00	163				
DS8M 1312	1312,00	164				
DS8M 1344	1344,00	168				
DS8M 1400	1400,00	175				
DS8M 1408	1408,00	176				
DS8M 1440	1440,00	180				
DS8M 1480	1480,00	185				
DS8M 1600	1600,00	200				
DS8M 1760	1760,00	220				
DS8M 1776	1776,00	222				

auf
Anfrage
on
request

Weitere Abmessungen auf Anfrage. Further sizes on request.

Zahnriemen – Meterware – Chloropren Open-ended Timing Belts – Chloroprene



zöllige Zahnriemen aus Chloropren *Timing belts made of Chloroprene*

Glasfaserzugstrang <i>Glass fibre cord</i>				Stahlzugstrang <i>Steel wire cord</i>			
Artikel-Bezeichnung <i>Type</i>	Riemenbreite <i>Belt width</i> (mm)	Rollenlänge <i>Length of roll</i> (Meter <i>metre</i>)	€ <i>Meter metre</i>	Artikel-Bezeichnung <i>Type</i>	Riemenbreite <i>Belt width</i> (mm)	Rollenlänge <i>Length of roll</i> (Meter <i>metre</i>)	€ <i>Meter metre</i>
MXL 025	6,35	30	auf Anfrage on request	H 050 - St	12,70	30	auf Anfrage on request
XL 025	6,35	30		H 075 - St	19,05	30	
XL 031	7,94	30		H 100 - St	25,40	30	
XL 037	9,53	30		H 150 - St	38,10	30	
XL 050	12,70	30		H 200 - St	50,80	30	
L 037	9,53	30					
L 050	12,70	30					
L 075	19,05	30					
L 100	25,40	30					
H 050	12,70	30					
H 075	19,05	30					
H 100	25,40	30					
H 150	38,10	30					
H 200	50,80	30					

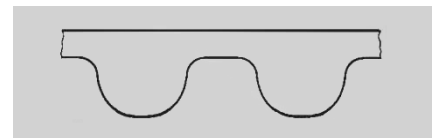

HTD-Zahnriemen aus Chloropren *HTD -timing belts made of Chloroprene*

Glasfaserzugstrang <i>Glass fibre cord</i>				Stahlzugstrang <i>Steel wire cord</i>			
Artikel-Bezeichnung <i>Type</i>	Riemenbreite <i>Belt width</i> (mm)	Rollenlänge <i>Length of roll</i> (Meter <i>metre</i>)	€ <i>Meter metre</i>	Artikel-Bezeichnung <i>Type</i>	Riemenbreite <i>Belt width</i> (mm)	Rollenlänge <i>Length of roll</i> (Meter <i>metre</i>)	€ <i>Meter metre</i>
8M 50	50,0	30	auf Anfrage on request	5M 06 - St	6,0	30	auf Anfrage on request
8M 85	85,0	30		5M 09 - St	9,0	30	
14M 25	25,0	30		5M 15 - St	15,0	30	
14M 40	40,0	30		5M 25 - St	25,0	30	
14M 55	55,0	30		8M 10 - St	10,0	30	
14M 85	85,0	30		8M 15 - St	15,0	30	
			8M 20 - St	20,0	30		
			8M 30 - St	30,0	30		
			8M 50 - St	50,0	30		
			8M 85 - St	85,0	30		
			14M 25 - St	25,0	30		
			14M 40 - St	40,0	30		
			14M 55 - St	55,0	30		
			14M 85 - St	85,0	30		

Weitere Abmessungen sowie endliche Zahnriemen mit Winkelabweichung auf Anfrage.
Further sizes and open-ended timing belts with angular deflection on request.

Mindest-Abnahmemenge auf Anfrage.
Minimum order quantity on request.

Zahnriemen – Meterware – Chloropren Open-ended Timing Belts – Chloroprene

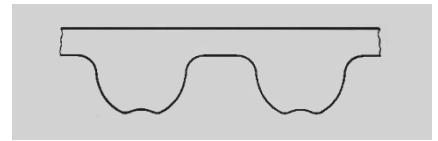

M – Zahnriemen aus Chloropren *Timing belts made of Chloroprene*

Glasfaserzugstrang *Glass fibre cord*

Artikel-Bezeichnung <i>Type</i>	Riemenbreite <i>Belt width</i> (mm)	Rollenlänge <i>Length of roll</i> (Meter <i>metre</i>)	€ Meter <i>metre</i>
3M 06	6,0	30	auf Anfrage on request
3M 09	9,0	30	
3M 15	15,0	30	
5M 10	10,0	30	
5M 15	15,0	30	
5M 20	20,0	30	
5M 25	25,0	30	
8M 10	10,0	30	
8M 15	15,0	30	
8M 20	20,0	30	
8M 25	25,0	30	
8M 30	30,0	30	

Weitere Abmessungen sowie endliche Zahnriemen mit Winkelabweichung auf Anfrage.
Further sizes and open-ended timing belts with angular deflection on request.

Zahnriemen – T – Polyurethan, mit Stahlzugstrang

Timing Belts – T – Polyurethane with steel wire cord

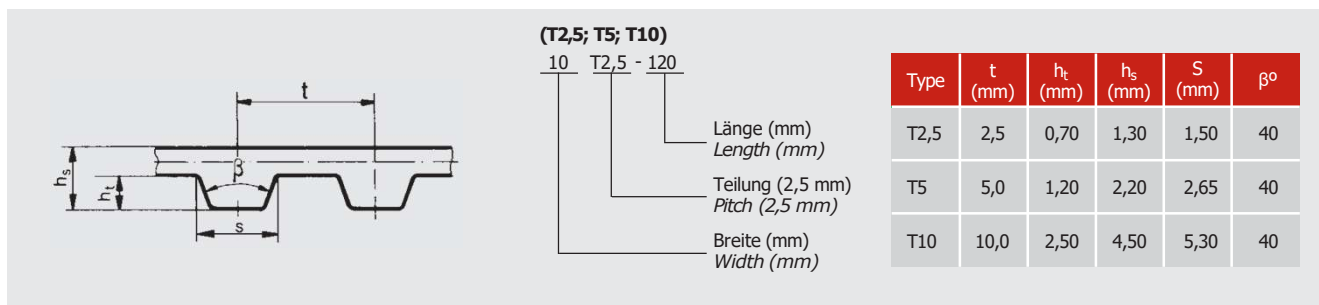

Type T2,5 – Teilung pitch 2,5 mm

Artikel- Bezeichnung Designation	Wirklänge Pitch length (mm)	Anzahl der Zähne Number of teeth	4 mm	6 mm	8 mm	10 mm	12 mm
			Breite width Code-No. 4	Breite width Code-No. 6	Breite width Code-No. 8	Breite width Code-No. 10	Breite width Code-No. 12
			€	€	€	€	€
			Stück each	Stück each	Stück each	Stück each	Stück each
T2,5 107,5	107,50	43					
T2,5 120	120,00	48					
T2,5 145	145,00	58					
T2,5 150	150,00	60					
T2,5 160	160,00	64					
T2,5 177,5	177,50	71					
T2,5 180	180,00	72					
T2,5 200	200,00	80					
T2,5 210	210,00	84					
T2,5 230	230,00	92					
T2,5 245	245,00	98					
T2,5 265	265,00	106					
T2,5 277,5	277,50	111					
T2,5 285	285,00	114					
T2,5 290	290,00	116					
T2,5 305	305,00	122					
T2,5 317,5	317,50	127					
T2,5 330	330,00	132					
T2,5 342,5	342,50	137					
T2,5 380	380,00	152					
T2,5 420	420,00	168					
T2,5 480	480,00	192					
T2,5 500	500,00	200					
T2,5 540	540,00	216					
T2,5 600	600,00	240					
T2,5 620	620,00	248					
T2,5 650	650,00	260					
T2,5 780	780,00	312					
T2,5 915	915,00	366					
T2,5 950	950,00	380					

auf
Anfrage
on
request

Weitere Abmessungen auf Anfrage. Further sizes on request.

Zahnriemen – T – Polyurethan, mit Stahlzugstrang

Timing Belts – T – Polyurethane with steel wire cord

Type T5 – Teilung pitch 5 mm

Artikel- Bezeichnung Designation	Wirklänge Pitch length (mm)	Anzahl der Zähne Number of teeth	6 mm	8 mm	10 mm	12 mm	16 mm	20 mm	25 mm
			Breite width Code-No. 6 € Stück each	Breite width Code-No. 8 € Stück each	Breite width Code-No. 10 € Stück each	Breite width Code-No. 12 € Stück each	Breite width Code-No. 16 € Stück each	Breite width Code-No. 20 € Stück each	Breite width Code-No. 25 € Stück each
T5 150	150,00	30							
T5 165	165,00	33							
T5 185	185,00	37							
T5 200	200,00	40							
T5 215	215,00	43							
T5 220	220,00	44							
T5 225	225,00	45							
T5 245	245,00	49							
T5 250	250,00	50							
T5 255	255,00	51							
T5 260	260,00	52							
T5 270	270,00	54							
T5 275	275,00	55							
T5 280	280,00	56							
T5 295	295,00	59							
T5 300	300,00	60							
T5 305	305,00	61							
T5 320	320,00	64							
T5 325	325,00	65							
T5 330	330,00	66							
T5 340	340,00	68							
T5 350	350,00	70							
T5 355	355,00	71							
T5 360	360,00	72							
T5 365	365,00	73							
T5 375	375,00	75							
T5 390	390,00	78							
T5 400	400,00	80							
T5 410	410,00	82							
T5 420	420,00	84							
T5 425	425,00	85							
T5 430	430,00	86							
T5 440	440,00	88							
T5 445	445,00	89							
T5 450	450,00	90							
T5 455	455,00	91							
T5 460	460,00	92							
T5 475	475,00	95							
T5 480	480,00	96							
T5 500	500,00	100							
T5 510	510,00	102							
T5 515	515,00	103							
T5 525	525,00	105							
T5 545	545,00	109							
T5 550	550,00	110							
T5 560	560,00	112							
T5 575	575,00	115							
T5 590	590,00	118							
T5 600	600,00	120							
T5 610	610,00	122							
T5 620	620,00	124							
T5 625	625,00	125							
T5 630	630,00	126							
T5 640	640,00	128							
T5 650	650,00	130							
T5 660	660,00	132							

auf
Anfrage
on
request

Zahnriemen – T – Polyurethan, mit Stahlzugstrang

Timing Belts – T – Polyurethane with steel wire cord

Type T5 – Teilung *pitch* 5 mm

Artikel- Bezeichnung <i>Designation</i>	Wirklänge <i>Pitch length</i> (mm)	Anzahl der Zähne <i>Number of teeth</i>	6 mm	8 mm	10 mm	12 mm	16 mm	20 mm	25 mm
			Breite <i>width</i> Code-No. 6	Breite <i>width</i> Code-No. 8	Breite <i>width</i> Code-No. 10	Breite <i>width</i> Code-No. 12	Breite <i>width</i> Code-No. 16	Breite <i>width</i> Code-No. 20	Breite <i>width</i> Code-No. 25
			€	€	€	€	€	€	€
			Stück <i>each</i>	Stück <i>each</i>	Stück <i>each</i>	Stück <i>each</i>	Stück <i>each</i>	Stück <i>each</i>	Stück <i>each</i>
T5 675	675,00	135							
T5 690	690,00	138							
T5 700	700,00	140							
T5 720	720,00	144							
T5 725	725,00	145							
T5 750	750,00	150							
T5 780	780,00	156							
T5 800	800,00	160							
T5 815	815,00	163							
T5 840	840,00	168							
T5 850	850,00	170							
T5 860	860,00	172							
T5 900	900,00	180							
T5 940	940,00	188							
T5 990	990,00	198							
T5 1000	1.000,00	200							
T5 1075	1.075,00	215							
T5 1100	1.100,00	220							
T5 1115	1.115,00	223							
T5 1140	1.140,00	228							
T5 1215	1.215,00	243							
T5 1315	1.315,00	263							
T5 1350	1.350,00	270							
T5 1380	1.380,00	276							
T5 1440	1.440,00	288							

auf
Anfrage
on
request

Weitere Abmessungen auf Anfrage. Further sizes on request.

Zahnriemen – T – Polyurethan, mit Stahlzugstrang

Timing Belts – T – Polyurethane with steel wire cord

Type T10 – Teilung *pitch* 10 mm

Artikel- Bezeichnung <i>Designation</i>	Wirklänge <i>Pitch length</i> (mm)	Anzahl der Zähne <i>Number of teeth</i>	10 mm	12 mm	16 mm	20 mm	25 mm	32 mm	50 mm
			Breite <i>width</i> Code-No. 10	Breite <i>width</i> Code-No. 12	Breite <i>width</i> Code-No. 16	Breite <i>width</i> Code-No. 20	Breite <i>width</i> Code-No. 25	Breite <i>width</i> Code-No. 32	Breite <i>width</i> Code-No. 50
			€ Stück <i>each</i>	€ Stück <i>each</i>	€ Stück <i>each</i>	€ Stück <i>each</i>	€ Stück <i>each</i>	€ Stück <i>each</i>	€ Stück <i>each</i>
T10 260	260,00	26							
T10 320	320,00	32							
T10 350	350,00	35							
T10 370	370,00	37							
T10 400	400,00	40							
T10 410	410,00	41							
T10 440	440,00	44							
T10 450	450,00	45							
T10 500	500,00	50							
T10 530	530,00	53							
T10 550	550,00	55							
T10 560	560,00	56							
T10 600	600,00	60							
T10 610	610,00	61							
T10 630	630,00	63							
T10 650	650,00	65							
T10 660	660,00	66							
T10 690	690,00	69							
T10 700	700,00	70							
T10 720	720,00	72							
T10 750	750,00	75							
T10 780	780,00	78							
T10 800	800,00	80							
T10 810	810,00	81							
T10 840	840,00	84							
T10 850	850,00	85							
T10 880	880,00	88							
T10 890	890,00	89							
T10 900	900,00	90							
T10 910	910,00	91							
T10 920	920,00	92							
T10 950	950,00	95							
T10 960	960,00	96							
T10 970	970,00	97							
T10 980	980,00	98							
T10 1000	1000,00	100							
T10 1010	1010,00	101							
T10 1050	1050,00	105							
T10 1080	1080,00	108							
T10 1100	1100,00	110							
T10 1110	1110,00	111							
T10 1140	1140,00	114							
T10 1150	1150,00	115							
T10 1200	1200,00	120							
T10 1210	1210,00	121							
T10 1240	1240,00	124							
T10 1250	1250,00	125							
T10 1300	1300,00	130							
T10 1320	1320,00	132							
T10 1350	1350,00	135							
T10 1390	1390,00	139							
T10 1400	1400,00	140							
T10 1420	1420,00	142							
T10 1440	1440,00	144							
T10 1450	1450,00	145							
T10 1460	1460,00	146							

auf
Anfrage
on
request

Weitere Abmessungen auf Anfrage. Further sizes on request.

Zahnriemen – T – Polyurethan, mit Stahlzugstrang Timing Belts – T – Polyurethane with steel wire cord

Type T10 – Teilung *pitch* 10 mm

Artikel- Bezeichnung <i>Designation</i>	Wirklänge <i>Pitch length</i> (mm)	Anzahl der Zähne <i>Number of teeth</i>	10 mm	12 mm	16 mm	20 mm	25 mm	32 mm	50 mm
			Breite <i>width</i> Code-No. 10	Breite <i>width</i> Code-No. 12	Breite <i>width</i> Code-No. 16	Breite <i>width</i> Code-No. 20	Breite <i>width</i> Code-No. 25	Breite <i>width</i> Code-No. 32	Breite <i>width</i> Code-No. 50
			€	€	€	€	€	€	€
			Stück <i>each</i>	Stück <i>each</i>	Stück <i>each</i>	Stück <i>each</i>	Stück <i>each</i>	Stück <i>each</i>	Stück <i>each</i>
T10 1500	1500,00	150							
T10 1560	1560,00	156							
T10 1600	1600,00	160							
T10 1610	1610,00	161							
T10 1700	1700,00	170							
T10 1750	1750,00	175							
T10 1780	1780,00	178							
T10 1800	1800,00	180							
T10 1880	1880,00	188							
T10 1960	1960,00	196							
T10 2250	2250,00	225							

auf
Anfrage
on
request

Weitere Abmessungen auf Anfrage. Further sizes on request.

Zahnriemen – AT – Polyurethan, mit HF-Cord Timing Belts – AT – Polyurethane with high flexible Steelcord

Type AT3 – Teilung *pitch* 3 mm

Artikel- Bezeichnung <i>Designation</i>	Wirklänge <i>Pitch length</i> (mm)	Anzahl der Zähne <i>Number of teeth</i>	10 mm	12 mm	16 mm	20 mm	25 mm	32 mm	50 mm
			Breite <i>width</i> Code-No. 10	Breite <i>width</i> Code-No. 12	Breite <i>width</i> Code-No. 16	Breite <i>width</i> Code-No. 20	Breite <i>width</i> Code-No. 25	Breite <i>width</i> Code-No. 32	Breite <i>width</i> Code-No. 50
			€	€	€	€	€	€	€
			Stück <i>each</i>	Stück <i>each</i>	Stück <i>each</i>	Stück <i>each</i>	Stück <i>each</i>	Stück <i>each</i>	Stück <i>each</i>
AT3 150	150,00	50							
AT3 201	210,00	67							
AT3 252	252,00	84							
AT3 267	267,00	89							
AT3 270	270,00	90							

auf Anfrage/
on request

Zahnriemen – AT – Polyurethan, mit Stahlzugstrang

Timing Belts – AT – Polyurethane with steel wire cord

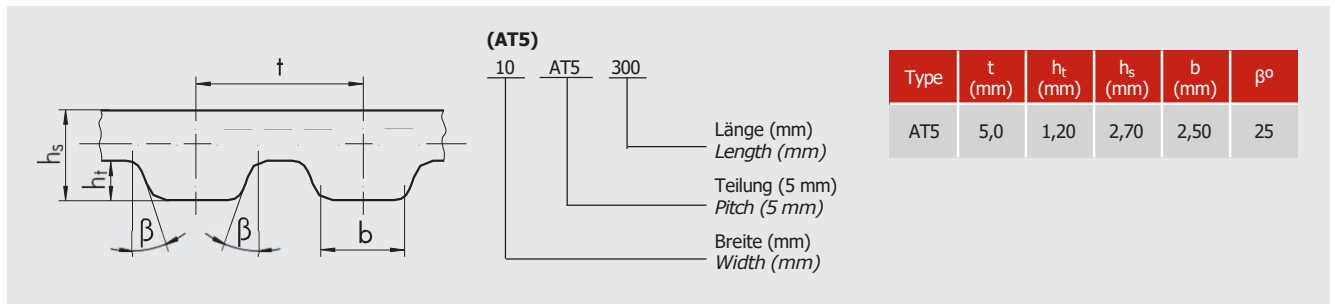

Type AT5 – Teilung pitch 5 mm

Artikel- Bezeichnung Designation	Wirklänge Pitch length (mm)	Anzahl der Zähne Number of teeth	6 mm	8 mm	10 mm	12 mm	16 mm	20 mm	25 mm
			Breite width Code-No. 6	Breite width Code-No. 8	Breite width Code-No. 10	Breite width Code-No. 12	Breite width Code-No. 16	Breite width Code-No. 20	Breite width Code-No. 25
			€ Stück each	€ Stück each	€ Stück each	€ Stück each	€ Stück each	€ Stück each	€ Stück each
AT5 200	200,00	40							
AT5 225	225,00	45							
AT5 255	255,00	51							
AT5 280	280,00	56							
AT5 300	300,00	60							
AT5 330	330,00	66							
AT5 340	340,00	68							
AT5 375	375,00	75							
AT5 390	390,00	78							
AT5 420	420,00	84							
AT5 450	450,00	90							
AT5 455	455,00	91							
AT5 500	500,00	100							
AT5 545	545,00	109							
AT5 600	600,00	120							
AT5 610	610,00	122							
AT5 660	660,00	132							
AT5 710	710,00	142							
AT5 720	720,00	144							
AT5 750	750,00	150							
AT5 780	780,00	156							
AT5 825	825,00	165							
AT5 860	860,00	172							
AT5 975	975,00	195							
AT5 1050	1.050,00	210							
AT5 1125	1.125,00	225							
AT5 1500	1.500,00	300							

auf
Anfrage
on
request

Weitere Abmessungen auf Anfrage. Further sizes on request.

Zahnriemen – AT – Polyurethan, mit Stahlzugstrang

Timing Belts – AT – Polyurethane with steel wire cord

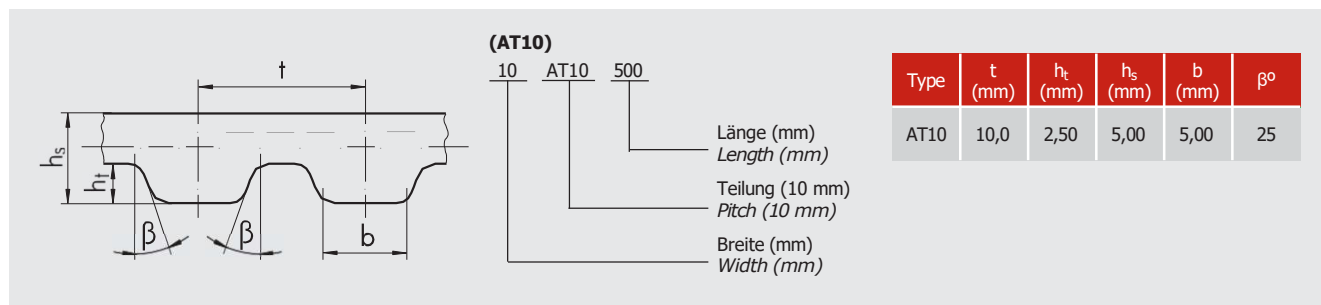

Type AT10 – Teilung pitch 10 mm

Artikel- Bezeichnung Designation	Wirklänge Pitch length (mm)	Anzahl der Zähne Number of teeth	10 mm	12 mm	16 mm	20 mm	25 mm	32 mm	50 mm
			Breite width Code-No. 10	Breite width Code-No. 12	Breite width Code-No. 16	Breite width Code-No. 20	Breite width Code-No. 25	Breite width Code-No. 32	Breite width Code-No. 50
			€ Stück each	€ Stück each	€ Stück each	€ Stück each	€ Stück each	€ Stück each	€ Stück each
AT10 500	500,00	50							
AT10 530	530,00	53							
AT10 560	560,00	56							
AT10 580	580,00	58							
AT10 600	600,00	60							
AT10 610	610,00	61							
AT10 660	660,00	66							
AT10 700	700,00	70							
AT10 730	730,00	73							
AT10 780	780,00	78							
AT10 800	800,00	80							
AT10 840	840,00	84							
AT10 890	890,00	89							
AT10 920	920,00	92							
AT10 960	960,00	96							
AT10 980	980,00	98							
AT10 1000	1.000,00	100							
AT10 1010	1.010,00	101							
AT10 1050	1.050,00	105							
AT10 1080	1.080,00	108							
AT10 1100	1.100,00	110							
AT10 1150	1.150,00	115							
AT10 1200	1.200,00	120							
AT10 1210	1.210,00	121							
AT10 1250	1.250,00	125							
AT10 1280	1.280,00	128							
AT10 1300	1.300,00	130							
AT10 1320	1.320,00	132							
AT10 1350	1.350,00	135							
AT10 1360	1.360,00	136							
AT10 1400	1.400,00	140							
AT10 1420	1.420,00	142							
AT10 1480	1.480,00	148							
AT10 1500	1.500,00	150							
AT10 1600	1.600,00	160							
AT10 1700	1.700,00	170							
AT10 1720	1.720,00	172							
AT10 1800	1.800,00	180							
AT10 1860	1.860,00	186							
AT10 1940	1.940,00	194							

auf
Anfrage
on
request

Weitere Abmessungen auf Anfrage. Further sizes on request.

Doppel-Zahnriemen – T – Polyurethan, mit Stahlzugstrang

Double Timing Belts – T – Polyurethane with steel wire cord

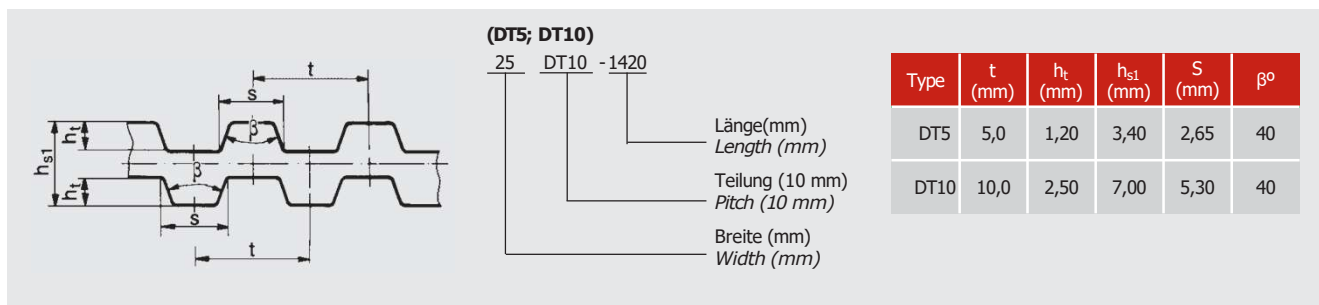

Type DT5 – Teilung pitch 5 mm

Artikel- Bezeichnung Designation	Wirklänge Pitch length (mm)	Anzahl der Zähne Number of teeth	6 mm	8 mm	10 mm	12 mm	16 mm	20 mm	25 mm	32 mm
			Breite width Code-No. 6	Breite width Code-No. 8	Breite width Code-No. 10	Breite width Code-No. 12	Breite width Code-No. 16	Breite width Code-No. 20	Breite width Code-No. 25	Breite width Code-No. 32
			€	€	€	€	€	€	€	€
			Stück each	Stück each	Stück each	Stück each	Stück each	Stück each	Stück each	Stück each
DT5 150	150,00	30								
DT5 300	300,00	60								
DT5 350	350,00	70								
DT5 400	400,00	80								
DT5 410	410,00	82								
DT5 450	450,00	90								
DT5 460	460,00	92								
DT5 480	480,00	96								
DT5 500	500,00	100								
DT5 515	515,00	103								
DT5 550	550,00	110								
DT5 590	590,00	118								
DT5 600	600,00	120								
DT5 620	620,00	124								
DT5 625	625,00	125								
DT5 650	650,00	130								
DT5 700	700,00	140								
DT5 750	750,00	150								
DT5 800	800,00	160								
DT5 815	815,00	163								
DT5 860	860,00	172								
DT5 900	900,00	180								
DT5 940	940,00	188								
DT5 1100	1.100,00	220								

**auf
Anfrage
on
request**

Weitere Abmessungen auf Anfrage. Further sizes on request.

Doppel-Zahnriemen – T – Polyurethan, mit Stahlzugstrang

Double Timing Belts – T – Polyurethane with steel wire cord

Type DT10 – Teilung *pitch* 10 mm

Artikel- Bezeichnung <i>Designation</i>	Wirklänge <i>Pitch length</i> (mm)	Anzahl der Zähne <i>Number of teeth</i>	10 mm	12 mm	16 mm	20 mm	25 mm	32 mm	50 mm
			Breite <i>width</i> Code-No. 10	Breite <i>width</i> Code-No. 12	Breite <i>width</i> Code-No. 16	Breite <i>width</i> Code-No. 20	Breite <i>width</i> Code-No. 25	Breite <i>width</i> Code-No. 32	Breite <i>width</i> Code-No. 50
			€ Stück <i>each</i>	€ Stück <i>each</i>	€ Stück <i>each</i>	€ Stück <i>each</i>	€ Stück <i>each</i>	€ Stück <i>each</i>	€ Stück <i>each</i>
DT10 260	260,00	26							
DT10 530	530,00	53							
DT10 600	600,00	60							
DT10 630	630,00	63							
DT10 660	660,00	66							
DT10 700	700,00	70							
DT10 720	720,00	72							
DT10 750	750,00	75							
DT10 800	800,00	80							
DT10 840	840,00	84							
DT10 900	900,00	90							
DT10 980	980,00	98							
DT10 1000	1000,00	100							
DT10 1100	1100,00	110							
DT10 1200	1200,00	120							
DT10 1210	1210,00	121							
DT10 1240	1240,00	124							
DT10 1250	1250,00	125							
DT10 1300	1300,00	130							
DT10 1320	1320,00	132							
DT10 1350	1350,00	135							
DT10 1400	1400,00	140							
DT10 1420	1420,00	142							
DT10 1500	1500,00	150							
DT10 1600	1600,00	160							
DT10 1610	1610,00	161							
DT10 1700	1700,00	170							
DT10 1800	1800,00	180							
DT10 1880	1880,00	188							

auf
Anfrage
on
request

Weitere Abmessungen auf Anfrage. Further sizes on request.

Zahnriemen – zöllig – Polyurethan, mit Aramidzugstrang Timing Belts – inch – Polyurethane with Aramid tension cord

Type MXL – Teilung pitch 2,032 mm

Artikel- Bezeichnung <i>Designation</i>	Wirklänge <i>Pitch length</i>		Anzahl der Zähne <i>Number of teeth</i>	1/8" Breite width ≈ 3,175 mm Code-No. 012	3/16" Breite width ≈ 4,763 mm Code-No. 019	1/4" Breite width ≈ 6,35 mm Code-No. 025	5/16" Breite width ≈ 7,94 mm Code-No. 031
	(Zoll <i>inch</i>)	(mm)		€ Stück each	€ Stück each	€ Stück each	€ Stück each
K 240 MXL	2,40	60,96	30				
K 280 MXL	2,80	71,12	35				
K 320 MXL	3,20	81,28	40				
K 360 MXL	3,60	91,44	45				
K 400 MXL	4,00	101,60	50				
K 440 MXL	4,40	111,76	55				
K 480 MXL	4,80	121,92	60				
K 520 MXL	5,20	132,08	65				
K 560 MXL	5,60	142,24	70				
K 600 MXL	6,00	152,40	75				
K 640 MXL	6,40	162,56	80				
K 680 MXL	6,80	172,72	85				
K 720 MXL	7,20	182,88	90				
K 760 MXL	7,60	193,04	95				
K 800 MXL	8,00	203,20	100				
K 840 MXL	8,40	213,36	105				
K 880 MXL	8,80	223,52	110				
K 920 MXL	9,20	233,68	115				
K 960 MXL	9,60	243,84	120				
K 1000 MXL	10,00	254,00	125				
K 1040 MXL	10,40	264,16	130				
K 1080 MXL	10,80	274,32	135				
K 1120 MXL	11,20	284,48	140				
K 1160 MXL	11,60	294,64	145				
K 1200 MXL	12,00	304,80	150				
K 1240 MXL	12,40	314,96	155				
K 1280 MXL	12,80	325,12	160				
K 1320 MXL	13,20	335,28	165				
K 1360 MXL	13,60	345,44	170				
K 1400 MXL	14,00	355,60	175				
K 1440 MXL	14,40	365,76	180				
K 1480 MXL	14,80	375,92	185				
K 1520 MXL	15,20	386,08	190				
K 1560 MXL	15,60	396,24	195				
K 1600 MXL	16,00	406,40	200				
K 1640 MXL	16,40	416,56	205				
K 1680 MXL	16,80	426,72	210				
K 1720 MXL	17,20	436,88	215				
K 1760 MXL	17,60	447,04	220				
K 1800 MXL	18,00	457,20	225				
K 1840 MXL	18,40	467,36	230				
K 1880 MXL	18,80	477,52	235				
K 1960 MXL	19,60	497,84	245				
K 2000 MXL	20,00	508,00	250				
K 2040 MXL	20,40	518,16	255				
K 2080 MXL	20,80	528,32	260				
K 2120 MXL	21,20	538,48	265				
K 2160 MXL	21,60	548,64	270				
K 2200 MXL	22,00	558,80	275				
K 2240 MXL	22,40	568,96	280				
K 2280 MXL	22,80	579,12	285				
K 2320 MXL	23,20	589,28	290				
K 2360 MXL	23,60	599,44	295				
K 2400 MXL	24,00	609,60	300				
K 2480 MXL	24,80	629,92	310				
K 2560 MXL	25,60	650,24	320				

auf
Anfrage
on
request

Zahnriemen – zöllig – Polyurethan, mit Aramidzugstrang Timing Belts – inch – Polyurethane with Aramid tension cord

Type MXL – Teilung pitch 2,032 mm

Artikel- Bezeichnung Designation	Wirklänge Pitch length		Anzahl der Zähne Number of teeth	1/8" Breite width ≈ 3,175 mm Code-No. 012	3/16" Breite width ≈ 4,763 mm Code-No. 019	1/4" Breite width ≈ 6,35 mm Code-No. 025	5/16" Breite width ≈ 7,94 mm Code-No. 031
	(Zoll inch)	(mm)		€ Stück each	€ Stück each	€ Stück each	€ Stück each
K 2640 MXL	26,40	670,56	330				
K 2720 MXL	27,20	690,88	340				
K 2800 MXL	28,00	711,20	350				
K 2880 MXL	28,80	731,52	360				
K 2960 MXL	29,60	751,84	370				
K 3040 MXL	30,40	772,16	380				
K 3120 MXL	31,20	792,48	390				
K 3200 MXL	32,00	812,80	400				

auf
Anfrage
on
request

Weitere Abmessungen auf Anfrage. Further sizes on request.

Zahnriemen – zöllig – Polyurethan, mit Stahlzugstrang Timing Belts – inch – Polyurethane with Steel wire cord

Type XL – Teilung pitch 5,08 mm

Artikel- Bezeichnung Designation	Wirklänge Pitch length		Anzahl der Zähne Number of teeth	1/4" Breite width ≈ 6,35 mm Code-No. 025	5/16" Breite width ≈ 7,94 mm Code-No. 031	3/8" Breite width ≈ 9,53 mm Code-No. 037	1/2" Breite width ≈ 12,7 mm Code-No. 050
	(Zoll inch)	(mm)		€ Stück each	€ Stück each	€ Stück each	€ Stück each
K 60 XL	6,00	152,40	30				
K 70 XL	7,00	177,80	35				
K 76 XL	7,60	193,04	38				
K 80 XL	8,00	203,20	40				
K 84 XL	8,40	213,36	42				
K 90 XL	9,00	228,60	45				
K 94 XL	9,40	238,76	47				
K 96 XL	9,60	243,84	48				
K 100 XL	10,00	254,00	50				
K 102 XL	10,20	259,08	51				
K 104 XL	10,40	264,16	52				
K 106 XL	10,60	269,24	53				
K 110 XL	11,00	279,40	55				
K 114 XL	11,40	289,56	57				
K 116 XL	11,60	294,64	58				
K 120 XL	12,00	304,80	60				
K 124 XL	12,40	314,96	62				
K 126 XL	12,60	320,04	63				
K 128 XL	12,80	325,12	64				
K 130 XL	13,00	330,20	65				
K 136 XL	13,60	345,44	68				
K 140 XL	14,00	355,60	70				
K 150 XL	15,00	381,00	75				
K 152 XL	15,20	386,08	76				
K 154 XL	15,40	391,16	77				
K 160 XL	16,00	406,40	80				
K 166 XL	16,60	421,64	83				
K 168 XL	16,80	426,72	84				
K 170 XL	17,00	431,80	85				
K 180 XL	18,00	457,20	90				
K 186 XL	18,60	472,44	93				
K 190 XL	19,00	482,60	95				
K 200 XL	20,00	508,00	100				
K 210 XL	21,00	533,40	105				
K 212 XL	21,20	538,48	106				
K 220 XL	22,00	558,80	110				
K 230 XL	23,00	584,20	115				
K 240 XL	24,00	609,60	120				
K 250 XL	25,00	635,00	125				
K 254 XL	25,40	645,16	127				
K 260 XL	26,00	660,40	130				
K 270 XL	27,00	685,80	135				
K 290 XL	29,00	736,60	145				
K 300 XL	30,00	762,00	150				
K 320 XL	32,00	812,80	160				
K 330 XL	33,00	838,20	165				
K 360 XL	36,00	914,40	180				
K 376 XL	37,60	955,04	188				
K 384 XL	38,40	975,36	192				
K 390 XL	39,00	990,60	195				
K 414 XL	41,40	1051,56	207				
K 460 XL	46,00	1168,40	230				
K 480 XL	48,00	1219,20	240				
K 512 XL	51,20	1300,48	256				
K 550 XL	55,00	1397,00	275				
K 564 XL	56,40	1432,56	282				

auf
Anfrage
on
request

Zahnriemen – zöllig – Polyurethan, mit Stahlzugstrang Timing Belts – inch – Polyurethane with Steel wire cord

Type XL – Teilung pitch 5,08 mm

Artikel- Bezeichnung Designation	Wirklänge Pitch length		Anzahl der Zähne Number of teeth	1/4" Breite width ≈ 6,35 mm Code-No. 025	5/16" Breite width ≈ 7,94 mm Code-No. 031	3/8" Breite width ≈ 9,53 mm Code-No. 037	1/2" Breite width ≈ 12,7 mm Code-No. 050
	(Zoll inch)	(mm)		€ Stück each	€ Stück each	€ Stück each	€ Stück each
K 630 XL	63,00	1600,20	315				
K 670 XL	67,00	1701,80	335				
auf Anfrage on request							

Weitere Abmessungen auf Anfrage. Further sizes on request.

Type L – Teilung pitch 9,525 mm

Artikel- Bezeichnung Designation	Wirklänge Pitch length		Anzahl der Zähne Number of teeth	1/2" Breite width ≈ 12,7 mm Code-No. 050	3/4" Breite width ≈ 19,05 mm Code-No. 075	1" Breite width ≈ 25,4 mm Code-No. 100	1 1/2" Breite width ≈ 38,1 mm Code-No. 150
	(Zoll inch)	(mm)		€ Stück each	€ Stück each	€ Stück each	€ Stück each
K 124 L	12,38	314,33	33				
K 150 L	15,00	381,00	40				
K 165 L	16,50	419,10	44				
K 173 L	17,25	438,15	46				
K 187 L	18,75	476,25	50				
K 210 L	21,00	533,40	56				
K 225 L	22,50	571,50	60				
K 240 L	24,00	609,60	64				
K 255 L	25,50	647,70	68				
K 270 L	27,00	685,80	72				
K 285 L	28,50	723,90	76				
K 300 L	30,00	762,00	80				
K 322 L	32,25	819,15	86				
K 345 L	34,50	876,30	92				
K 367 L	36,75	933,45	98				
K 375 L	37,50	952,50	100				
K 390 L	39,00	990,60	104				
K 420 L	42,00	1066,80	112				
K 427 L	42,75	1085,85	114				
K 450 L	45,00	1143,00	120				
K 480 L	48,00	1219,20	128				
K 510 L	51,00	1295,40	136				
K 525 L	52,50	1333,50	140				
K 540 L	54,00	1371,60	144				
K 600 L	60,00	1524,00	160				
auf Anfrage on request							

Weitere Abmessungen auf Anfrage. Further sizes on request.

Zahnriemen als Meterware (endlich) oder endlos verschweißt Open-Ended or Joined Endless Timing Belts made of Polyurethane

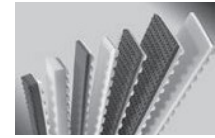

Profil Profile		XL	L	H	XH	5M	8M	14M
Teilung Pitch	t	5,08	9,525	12,7	22,225	5,00	8,00	14,00
Zahnwinkel Tooth angle	β	50°	40°	40°	40°	—	—	—
Zahnhöhe Height of tooth	ht	1,27	1,90	2,30	6,35	2,06	3,38	6,00
Zahnbreite Width of tooth	s	2,57	4,65	6,12	12,57	—	—	—
Ges.-Riemenhöhe Total belt thickness	h _s	2,30	3,60	4,30	11,20	3,60	5,60	10,00

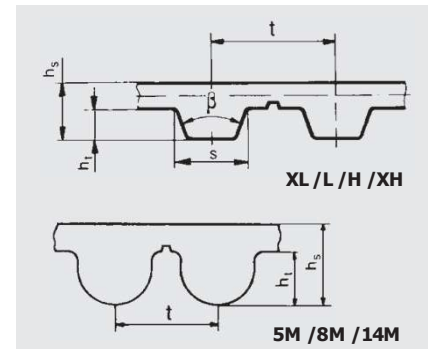

Aufbau: Polyurethanzahnriemen mit
Stahlzugstrang /Aramidzugstrang
Construction: Polyurethane timing belt
with steel wire cord /aramid cord

Artikel-Bezeichnung Designation	Teilung Pitch (mm)	Riemenbreite Belt width (mm)	Stahlzugstrang Steel cord		Aramidzugstrang Aramid cord	
			linear € Meter metre	-V- Endlosverbindung Joining endless € Stück each	linear € Meter metre	-V- Endlosverbindung Joining endless € Stück each
XL 025	5,080	6,35				
XL 031	5,080	7,94				
XL 037	5,080	9,53				
XL 050	5,080	12,70				
XL 075	5,080	19,05				
XL 100	5,080	25,40				
XL 200	5,080	50,80				
L 037	9,525	9,53				
L 050	9,525	12,70				
L 075	9,525	19,05				
L 100	9,525	25,40				
L 150	9,525	38,10				
L 200	9,525	50,80				
L 400	9,525	101,60				
H 050	12,700	12,70				
H 075	12,700	19,05				
H 100	12,700	25,40				
H 150	12,700	38,10				
H 200	12,700	50,80				
H 300	12,700	76,20				
H 400	12,700	101,60				
H 600	12,700	152,40				
XH 100	22,225	25,40				
XH 200	22,225	50,80				
XH 300	22,225	76,20				
XH 400	22,225	101,60				
5M 10	5,000	10,00				
5M 15	5,000	15,00				
5M 20	5,000	20,00				
5M 25	5,000	25,00				
5M 50	5,000	50,00				
5M 100	5,000	100,00				

auf
Anfrage
on
request

Zahnriemen als Meterware (endlich) oder endlos verschweißt Open-Ended or Joined Endless Timing Belts made of Polyurethane

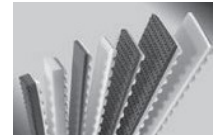

Artikel-Bezeichnung Designation	Teilung Pitch (mm)	Riemenbreite Belt width (mm)	Stahlzugstrang Steel cord		Aramidzugstrang Aramid cord	
			linear € Meter metre	-V- Endlosverbindung Joining endless € Stück each	linear € Meter metre	-V- Endlosverbindung Joining endless € Stück each
8M 15	8,000	15,00				
8M 20	8,000	20,00				
8M 25	8,000	25,00				
8M 30	8,000	30,00				
8M 50	8,000	50,00				
8M 85	8,000	85,00				
8M 100	8,000	100,00				
8M 150	8,000	150,00				
14M 25	14,000	25,00				
14M 40	14,000	40,00				
14M 55	14,000	55,00				
14M 85	14,000	85,00				
14M 100	14,000	100,00				
14M 115	14,000	115,00				
14M 150	14,000	150,00				
14M 170	14,000	170,00				

**auf
Anfrage
on
request**

Mindestlänge für verschweißte Zahnriemen Minimum length for spliced timing belts		
Riemenbreite Belt width (mm)	Profil Profile	Mindestlänge Minimum length (mm)
- 50	L, H, 5M, 8M	700
- 50	XH, 14M	900
51- 100	L, H, 5M, 8M	900
101-	8M, 14M	1100

Weitere Ausführungen und Breiten auf Anfrage.
Further constructions and widths on request.

Rollenlänge Length of roll: 50 m
Aufpreis für Anschnitte Surcharge or shorter length: 10 %

Zahnriemen als Meterware (endlich) oder endlos verschweißt Open-Ended or Joined Endless Timing Belts made of Polyurethane

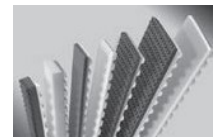

Profil Profile	T5	T10	T20	AT5	AT10	AT20	
Teilung Pitch	t	5,0	10,0	20,0	5,0	10,0	20,0
Zahnwinkel Tooth angle	β	40°	40°	40°	50°	50°	50°
Zahnhöhe Height of tooth	ht	1,20	2,50	5,00	1,20	2,50	5,00
Zahnbreite Width of tooth	s	2,65	5,30	10,15	2,50	5,00	10,00
Ges.-Riemenhöhe Total belt thickness	hs	2,20	4,50	8,00	2,70	4,50	8,00

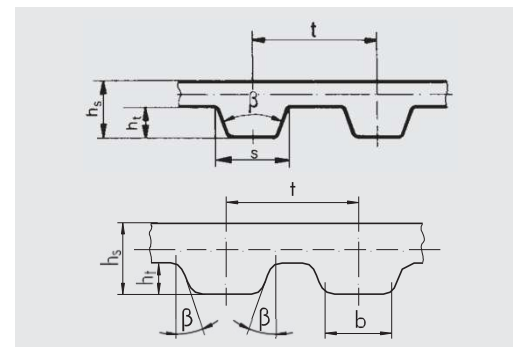

Aufbau: Polyurethanzahnriemen mit Stahlzugstrang /
Aramidzugstrang
Construction: Polyurethane timing belt with
steel wire cord / aramid cord

Zahnriemen als Meterware (endlich) oder endlos verschweißt Open-Ended or Joined Endless Timing Belts made of Polyurethane



Artikel-Bezeichnung <i>Designation</i>	Teilung <i>Pitch</i> (mm)	Riemenbreite <i>Belt width</i> (mm)	Stahzugstrang <i>Steel cord</i>		Aramidzugstrang <i>Aramid cord</i>	
			linear € Meter metre	-V- Endlosverbindung <i>Joining endless</i> € Stück each	linear € Meter metre	-V- Endlosverbindung <i>Joining endless</i> € Stück each
10 T5	5,0	10,0				
16 T5	5,0	16,0				
25 T5	5,0	25,0				
32 T5	5,0	32,0				
50 T5	5,0	50,0				
75 T5	5,0	75,0				
100 T5	5,0	100,0				
12 T10	10,0	12,0				
16 T10	10,0	16,0				
25 T10	10,0	25,0				
32 T10	10,0	32,0				
40 T10	10,0	40,0				
50 T10	10,0	50,0				
75 T10	10,0	75,0				
100 T10	10,0	100,0				
150 T10	10,0	150,0				
25 T20	20,0	25,0				
32 T20	20,0	32,0				
50 T20	20,0	50,0				
75 T20	20,0	75,0				
100 T20	20,0	100,0				
150 T20	20,0	150,0				
10 AT5	5,0	10,0				
16 AT5	5,0	16,0				
25 AT5	5,0	25,0				
32 AT5	5,0	32,0				
50 AT5	5,0	50,0				
75 AT5	5,0	75,0				
100 AT5	5,0	100,0				
16 AT10	10,0	16,0				
25 AT10	10,0	25,0				
32 AT10	10,0	32,0				
50 AT10	10,0	50,0				
75 AT10	10,0	75,0				
100 AT10	10,0	100,0				
150 AT10	10,0	150,0				
25 AT20	20,0	25,0				
32 AT20	20,0	32,0				
50 AT20	20,0	50,0				
75 AT20	20,0	75,0				
100 AT20	20,0	100,0				
150 AT20	20,0	150,0				

auf
Anfrage
on
request

Mindestlänge für verschweißte Zahnriemen <i>Minimum length for spliced timing belts</i>		
Riemenbreite <i>Belt width</i> (mm)	Profil <i>Profile</i>	Mindestlänge <i>Minimum length</i> (mm)
- 50	T5, T10, AT5, AT10	700
- 50	T20, AT20	900
51- 100	T5, T10, AT5, AT10, AT20	900
101-	T10, T20, AT10, AT20	1100

Weitere Ausführungen und Breiten auf Anfrage.
Further constructions and widths on request.

Rollenlänge *Length of roll: 50 m*

Aufpreis für Anschnitte *Surcharge or shorter length: 10 %*

Zahnriemen als Meterware (endlich) Open-Ended Timing Belts

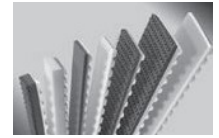

Profil Profile		AT5	AT10	AT20
Teilung Pitch	t	5,0	10,0	20,0
Zahnwinkel Tooth angle	β	50°	50°	50°
Zahnhöhe Height of tooth	ht	1,20	2,50	5,00
Zahnbreite Width of tooth	s	2,50	5,00	10,00
Ges.-Riemenhöhe Total belt thickness	hs	2,70	4,50	8,00

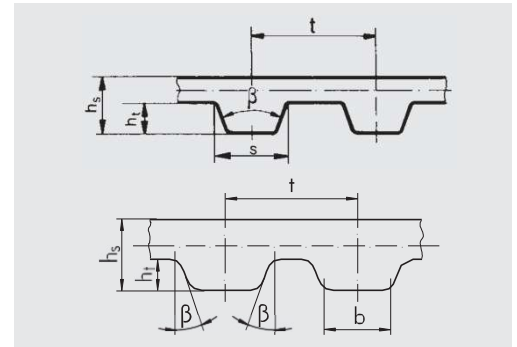

**Aufbau: Polyurethanzahnriemen mit Stahlzugstrang /
Aramidzugstrang**
Construction: Polyurethane timing belt with
steel wire cord / aramid cord

Stahlzugstrang Steel wire cord

Artikel-Bezeichnung Designation	Teilung Pitch (mm)	Riemenbreite Belt width (mm)	inear € Meter metre
10 ATL5	5,0	10,0	auf Anfrage on request
16 ATL5	5,0	16,0	
25 ATL5	5,0	25,0	
32 ATL5	5,0	32,0	
50 ATL5	5,0	50,0	
75 ATL5	5,0	75,0	
100 ATL5	5,0	100,0	
16 ATL10	10,0	16,0	
25 ATL10	10,0	25,0	
32 ATL10	10,0	32,0	
50 ATL10	10,0	50,0	
75 ATL10	10,0	75,0	
100 ATL10	10,0	100,0	
150 ATL10	10,0	150,0	
25 ATL20	20,0	25,0	
32 ATL20	20,0	32,0	
50 ATL20	20,0	50,0	
75 ATL20	20,0	75,0	
100 ATL20	20,0	100,0	
150 ATL20	20,0	150,0	

Mindestlänge für verschweißte Zahnriemen
Minimum length for spliced timing belts

Riemenbreite Belt width (mm)	Profil Profile	Mindestlänge Minimum length (mm)
– 50	ATL5, ATL10	700
– 50	ATL20	900
51– 100	ATL5, ATL10, ATL20	900
101–	ATL10, ATL20	1100

Weitere Ausführungen und Breiten auf Anfrage.
Further constructions and widths on request.

Rollenlänge Length of roll: 50 m
Aufpreis für Anschnitte Surcharge or shorter length: 10 %

Spur Zahnriemen als Meterware (endlich) oder endlos verschweißt

Open-Ended or Joined Endless Self Tracking Belts

Profil Profile		T5	T10	AT10
Teilung Pitch	t	5,0	10,0	10,0
Zahnwinkel Tooth angle	β	40°	40°	50°
Zahnhöhe Height of tooth	ht	1,20	2,50	2,50
Zahnbreite Width of tooth	s	2,65	5,30	5,00
Ges.-Riemenhöhe Total belt thickness	hs	2,20	4,50	4,50

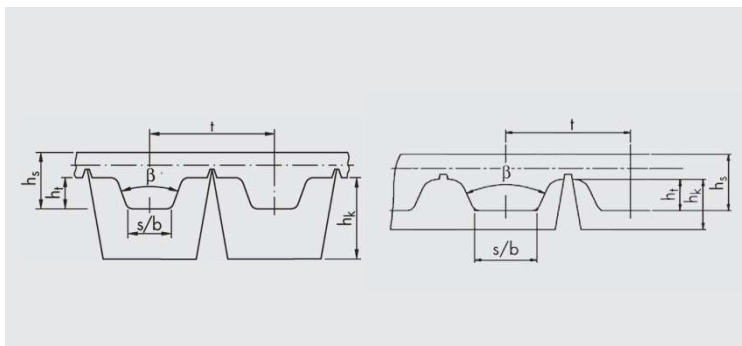

Aufbau: Polyuretan mit Stahlzugstrang
Construction: Polyurethane with steel wire cord

KEIL gekerbt – extrudiert Notched V-guide – extruded				
Artikel-Bezeichnung Designation	Keilleiste (Breite x Höhe / h _k) V-guide (width x height / h _k) (mm)	Riemenbreite Belt width (mm)	linear € Meter metre	-V- Endlosverbindung Joining endless € Stück each
25 T5K6	5,0	25,0		
32 T5K6	5,0	32,0		
50 T5K6	5,0	50,0		
75 T5K6	5,0	75,0		
100 T5K6	5,0	100,0		
25 T10K6	10,0	25,0		
32 T10K6	10,0	32,0		
50 T10K6	10,0	50,0		
75 T10K6	10,0	75,0		
100 T10K6	10,0	100,0		
32 T10K13	10,0	32,0		
50 T10K13	10,0	50,0		
75 T10K13	10,0	75,0		
100 T10K13	10,0	100,0		
25 AT5K6	5,0	25,0		
32 AT5K6	5,0	32,0		
50 AT5K6	5,0	50,0		
75 AT5K6	5,0	75,0		
100 AT5K6	5,0	100,0		
25 AT10K6	10,0	25,0		
32 AT10K6	10,0	32,0		
50 AT10K6	10,0	50,0		
75 AT10K6	10,0	75,0		
100 AT10K6	10,0	100,0		
100AT10K13	10,0	100,0		
32 AT10K13	10,0	32,0		
50 AT10K13	10,0	50,0		
75 AT10K13	10,0	75,0		

**auf
Anfrage
on
request**

Mindestlänge für verschweißte Spur Zahnriemen Minimum lengths for spliced self tracking belts:

T5 / T10 / AT10 = 1000 mm

Rollenlänge Length of roll: 50m + 100m

Auf Wunsch mit PAZ-Gewebe. Optional with PAZ-fabric on tooth surface.

Weitere Ausführungen und Breiten auf Anfrage. Further constructions and widths on request.

Klemmplatten für Polyurethan-Zahnriemen

Clamping plates for Polyurethane-Timing Belts

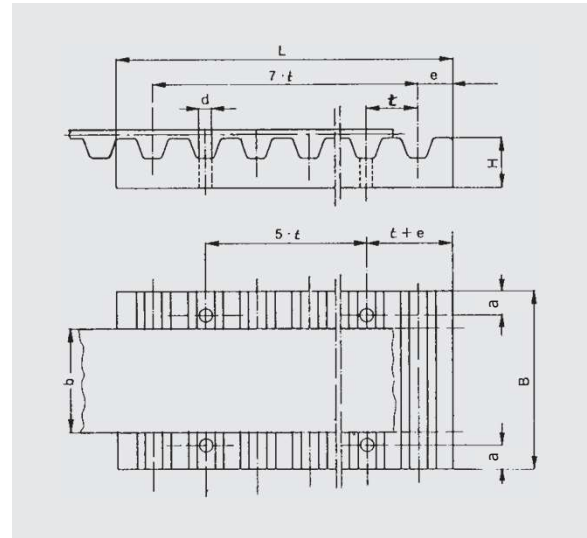

Artikel- Bezeichnung Designation	Teilung Pitch t (mm)	Riemenbreite Belt width b (mm)	Material	B (mm)	a (mm)	L (mm)	e (mm)	H (mm)	d (mm)	Gewicht Weight ≈ (kg)	€ Stück each
CP- 6 T5	5,000	6,00	Al	25,0	6,0	41,8	3,2	8,0	5,5	0,020	auf Anfrage on request
CP- 10 T5	5,000	10,00	Al	29,0	6,0	41,8	3,2	8,0	5,5	0,025	
CP- 16 T5	5,000	16,00	Al	35,0	6,0	41,8	3,2	8,0	5,5	0,030	
CP- 25 T5	5,000	25,00	Al	44,0	6,0	41,8	3,2	8,0	5,5	0,036	
CP- 32 T5	5,000	32,00	Al	51,0	6,0	41,8	3,2	8,0	5,5	0,042	
CP- 50 T5	5,000	50,00	Al	69,0	6,0	41,8	3,2	8,0	5,5	0,051	
CP- 16 T10	10,000	16,00	Al	41,0	8,0	80,0	5,0	15,0	9,0	0,115	
CP- 25 T10	10,000	25,00	Al	50,0	8,0	80,0	5,0	15,0	9,0	0,140	
CP- 32 T10	10,000	32,00	Al	57,0	8,0	80,0	5,0	15,0	9,0	0,160	
CP- 50 T10	10,000	50,00	Al	75,0	8,0	80,0	5,0	15,0	9,0	0,215	
CP- 75 T10	10,000	75,00	Al	100,0	8,0	80,0	5,0	15,0	9,0	0,290	
CP-100 T10	10,000	100,00	Al	125,0	8,0	80,0	5,0	15,0	9,0	0,370	
CP- 25 T20	20,000	25,00	Al	56,0	10,0	160,0	10,0	20,0	11,0	0,385	
CP- 32 T20	20,000	32,00	Al	65,0	10,0	160,0	10,0	20,0	11,0	0,450	
CP- 50 T20	20,000	50,00	Al	81,0	10,0	160,0	10,0	20,0	11,0	0,570	
CP- 75 T20	20,000	75,00	Al	106,0	10,0	160,0	10,0	20,0	11,0	0,755	
CP-100 T20	20,000	100,00	Al	132,0	10,0	160,0	10,0	20,0	11,0	0,940	
CP- 6 AT5	5,000	6,00	Al	25,0	6,0	41,8	3,2	8,0	5,5	0,016	
CP- 10 AT5	5,000	10,00	Al	29,0	6,0	41,8	3,2	8,0	5,5	0,019	
CP- 16 AT5	5,000	16,00	Al	35,0	6,0	41,8	3,2	8,0	5,5	0,024	
CP- 25 AT5	5,000	25,00	Al	44,0	6,0	41,8	3,2	8,0	5,5	0,031	
CP- 32 AT5	5,000	32,00	Al	51,0	6,0	41,8	3,2	8,0	5,5	0,036	
CP- 50 AT5	5,000	50,00	Al	61,0	6,0	41,8	3,2	8,0	5,5	0,043	
CP- 16 AT10	10,000	16,00	Al	41,0	8,0	80,0	5,0	15,0	9,0	0,110	
CP- 25 AT10	10,000	25,00	Al	50,0	8,0	80,0	5,0	15,0	9,0	0,135	
CP- 32 AT10	10,000	32,00	Al	57,0	8,0	80,0	5,0	15,0	9,0	0,155	
CP- 50 AT10	10,000	50,00	Al	75,0	8,0	80,0	5,0	15,0	9,0	0,205	
CP- 75 AT10	10,000	75,00	Al	100,0	8,0	80,0	5,0	15,0	9,0	0,280	
CP-100 AT10	10,000	100,00	Al	125,0	8,0	80,0	5,0	15,0	9,0	0,350	
CP- 25 AT20	20,000	25,00	Al	56,0	10,0	160,0	10,0	20,0	11,0	0,385	
CP- 32 AT20	20,000	32,00	Al	65,0	10,0	160,0	10,0	20,0	11,0	0,450	
CP- 50 AT20	20,000	50,00	Al	81,0	10,0	160,0	10,0	20,0	11,0	0,570	
CP- 75 AT20	20,000	75,00	Al	106,0	10,0	160,0	10,0	20,0	11,0	0,755	
CP-100 AT20	20,000	100,00	Al	132,0	10,0	160,0	10,0	20,0	11,0	0,940	

Klemmplatten für Zahnriemen

Clamping plates for Timing Belts

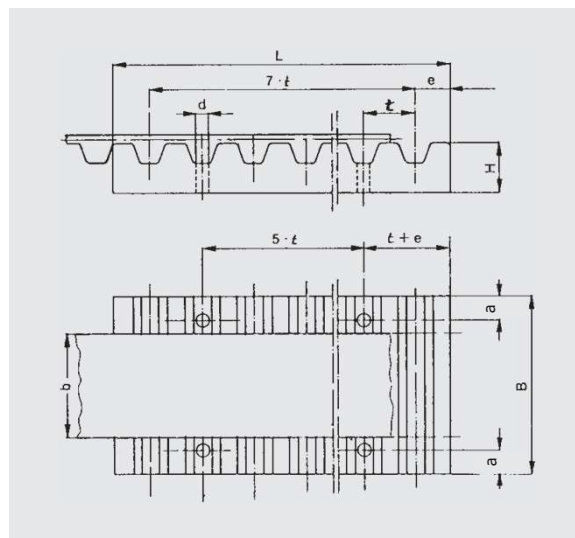

Artikel- Bezeichnung Designation	Teilung Pitch t (mm)	Riemenbreite Belt width b (mm)	Material	B (mm)	a (mm)	L (mm)	e (mm)	H (mm)	d (mm)	Gewicht Weight ≈ (kg)	€ Stück each
CP-XL 025	5,080	6,35	Al	25,5	6,0	42,5	3,5	8,0	5,5	0,020	auf Anfrage on request
CP-XL 037	5,080	9,53	Al	28,5	6,0	42,5	3,5	8,0	5,5	0,025	
CP-XL 050	5,080	12,70	Al	32,0	6,0	42,5	3,5	8,0	5,5	0,027	
CP-XL 075	5,080	19,05	Al	38,0	6,0	42,5	3,5	8,0	5,5	0,032	
CP-XL 100	5,080	25,40	Al	45,0	6,0	42,5	3,5	8,0	5,5	0,038	
CP-L 037	9,525	9,53	Al	36,0	8,0	76,6	5,0	15,0	9,0	0,095	
CP-L 050	9,525	12,70	Al	39,0	8,0	76,6	5,0	15,0	9,0	0,104	
CP-L 075	9,525	19,05	Al	45,0	8,0	76,6	5,0	15,0	9,0	0,121	
CP-L 100	9,525	25,40	Al	51,5	8,0	76,6	5,0	15,0	9,0	0,140	
CP-L 150	9,525	38,10	Al	64,0	8,0	76,6	5,0	15,0	9,0	0,177	
CP-L 200	9,525	50,80	Al	77,0	8,0	76,6	5,0	15,0	9,0	0,215	
CP-H 050	12,700	12,70	Al	45,0	10,0	106,9	9,0	22,0	11,0	0,050	
CP-H 075	12,700	19,05	Al	51,0	10,0	106,9	9,0	22,0	11,0	0,075	
CP-H 100	12,700	25,40	Al	57,5	10,0	106,9	9,0	22,0	11,0	0,100	
CP-H 150	12,700	38,10	Al	70,0	10,0	106,9	9,0	22,0	11,0	0,150	
CP-H 200	12,700	50,80	Al	83,0	10,0	106,9	9,0	22,0	11,0	0,200	
CP-H 300	12,700	76,20	Al	108,0	10,0	106,9	9,0	22,0	11,0	0,300	
CP-H 400	12,700	101,60	Al	134,0	10,0	106,9	9,0	22,0	11,0	0,400	
CP-5M 06	5,000	6,00	Al	25,0	6,0	41,8	3,2	8,0	5,5	0,015	
CP-5M 09	5,000	9,00	Al	28,0	6,0	41,8	3,2	8,0	5,5	0,018	
CP-5M 15	5,000	15,00	Al	34,0	6,0	41,8	3,2	8,0	5,5	0,022	
CP-5M 25	5,000	25,00	Al	44,0	6,0	41,8	3,2	8,0	5,5	0,030	
CP-8M 10	8,000	10,00	Al	35,0	8,0	66,0	5,0	15,0	9,0	0,075	
CP-8M 15	8,000	15,00	Al	40,0	8,0	66,0	5,0	15,0	9,0	0,085	
CP-8M 20	8,000	20,00	Al	45,0	8,0	66,0	5,0	15,0	9,0	0,100	
CP-8M 30	8,000	30,00	Al	55,0	8,0	66,0	5,0	15,0	9,0	0,120	
CP-8M 50	8,000	50,00	Al	75,0	8,0	66,0	5,0	15,0	9,0	0,170	
CP-8M 85	8,000	85,00	Al	110,0	8,0	66,0	5,0	15,0	9,0	0,250	
CP-14M 25	14,000	25,00	Al	56,0	10,0	116,0	9,0	22,0	11,0	0,315	
CP-14M 40	14,000	40,00	Al	71,0	10,0	116,0	9,0	22,0	11,0	0,405	
CP-14M 55	14,000	55,00	Al	86,0	10,0	116,0	9,0	22,0	11,0	0,495	
CP-14M 85	14,000	85,00	Al	116,0	10,0	116,0	9,0	22,0	11,0	0,860	
CP-14M 115	14,000	115,00	Al	146,0	10,0	116,0	9,0	22,0	11,0	1,195	

Weitere Abmessungen auf Anfrage. Further sizes on request.

Al = Aluminium

Verschiedenste Bearbeitungsmöglichkeiten für Ihren Polyurethan-Antrieb:

Different kinds of conditioning your Polyurethane drive:

Zahnriemen können durch Rückenbeschichtung, Gewebeauflagen und Mitnehmer den unterschiedlichsten Anforderungen im Bereich der Förder-, Steuerungs- und Handhabungstechnik angepasst werden.

timing belts can be adapted to the widest variety of demands in the sectors of conveying, control and handling technology through their rear coating, fabric inlays and conveyor cleats.

Anwendungsbeispiele:

- Möbelindustrie - Linatex rot
- Holzindustrie - Supergrip grün
- Lebensmittelindustrie - HV1-, HV2-Folie
- Verpackungsindustrie - Schaumvulkolan
- Lebensmittelindustrie und Holzindustrie - Noppen, Mitnehmer weiß

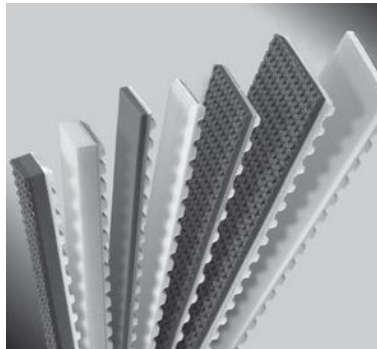

areas of application:

- furniture industry - Linatex red
- timber industry - Supergrip green
- food processing industry - HV1- and HV2-films
- packaging industry - foam Vulkolan
- food processing industry and timber industry - dimples, white conveyor cleats

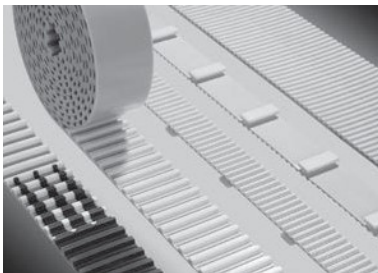

- ✓ verschweißte Polyurethan-Zahnriemen als Rollenware mit T-Profil-Beschichtung
joined polyurethane timing belts from bulk stock with back coverings in T-profile

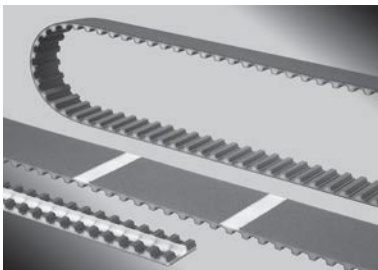

- ✓ Polyurethan-Zahnriemen mit PAR/PAZ-Gewebe
timing belts made of polyurethane with nylon teeth or back facing (PAR/PAZ)
- ✓ mit eingeschweißter Keilführungsleiste
with shrink-wrapped gib for wedges



- ✓ Polyurethan-Zahnriemen mit bearbeiteten Zähnen und Bohrungen
timing belts made of polyurethane with arranged teeth or holes
- ✓ mit aufgeschweißten Mitnehmern, individuell nach Zeichnung
with welded conveyor cleats, individually according to drawing

GSM GUARDING
SURFACE
METAL

GSM GmbH

Zeppelinweg 2
99734 Nordhausen

j.jung@gsmotion.com
Tel.: +49 (0) 03631 65-128-330

www.gsmotion.de